

Barbarian's Settlement

IT IS RECOMMENDED TO USE GLUE

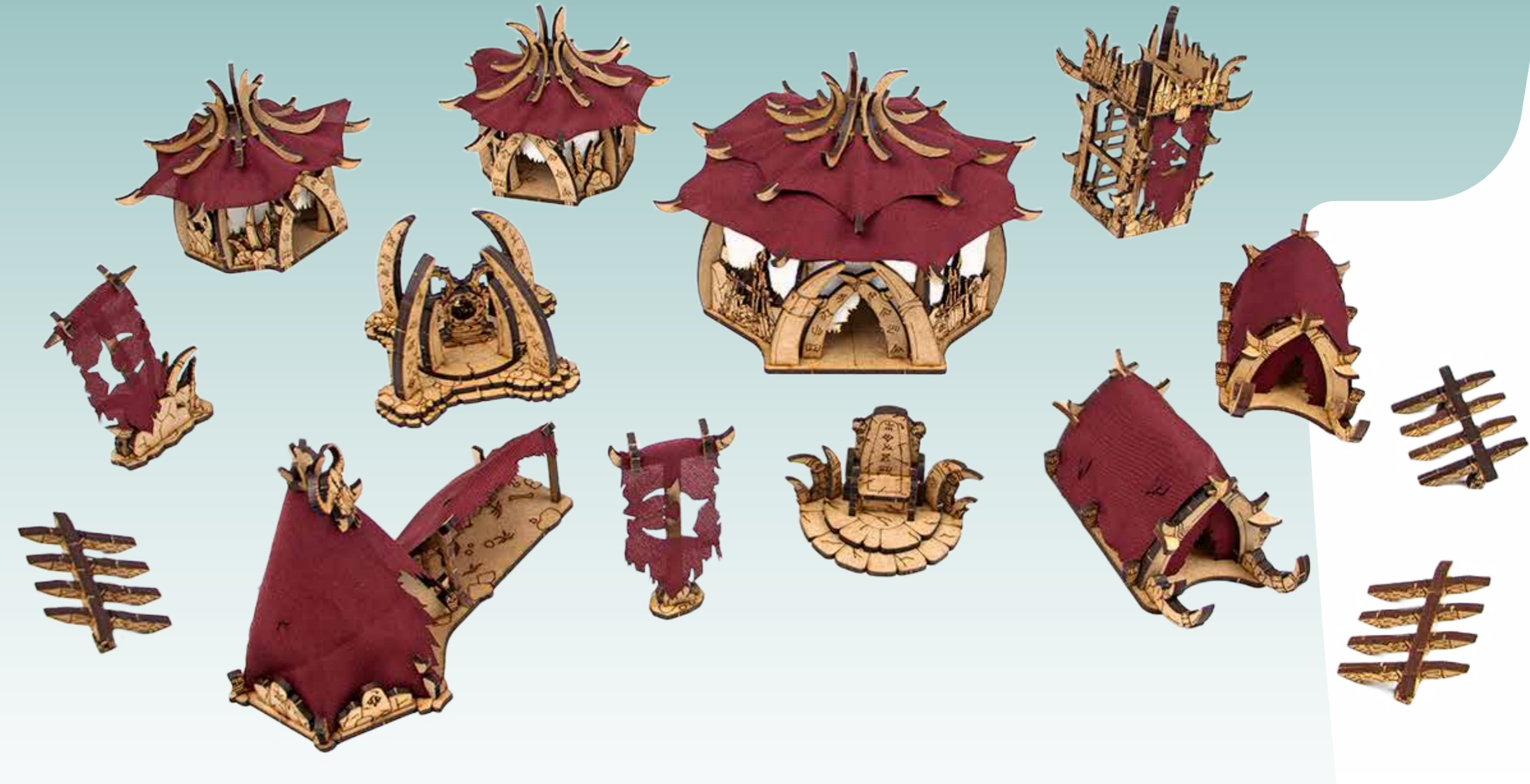

A

1

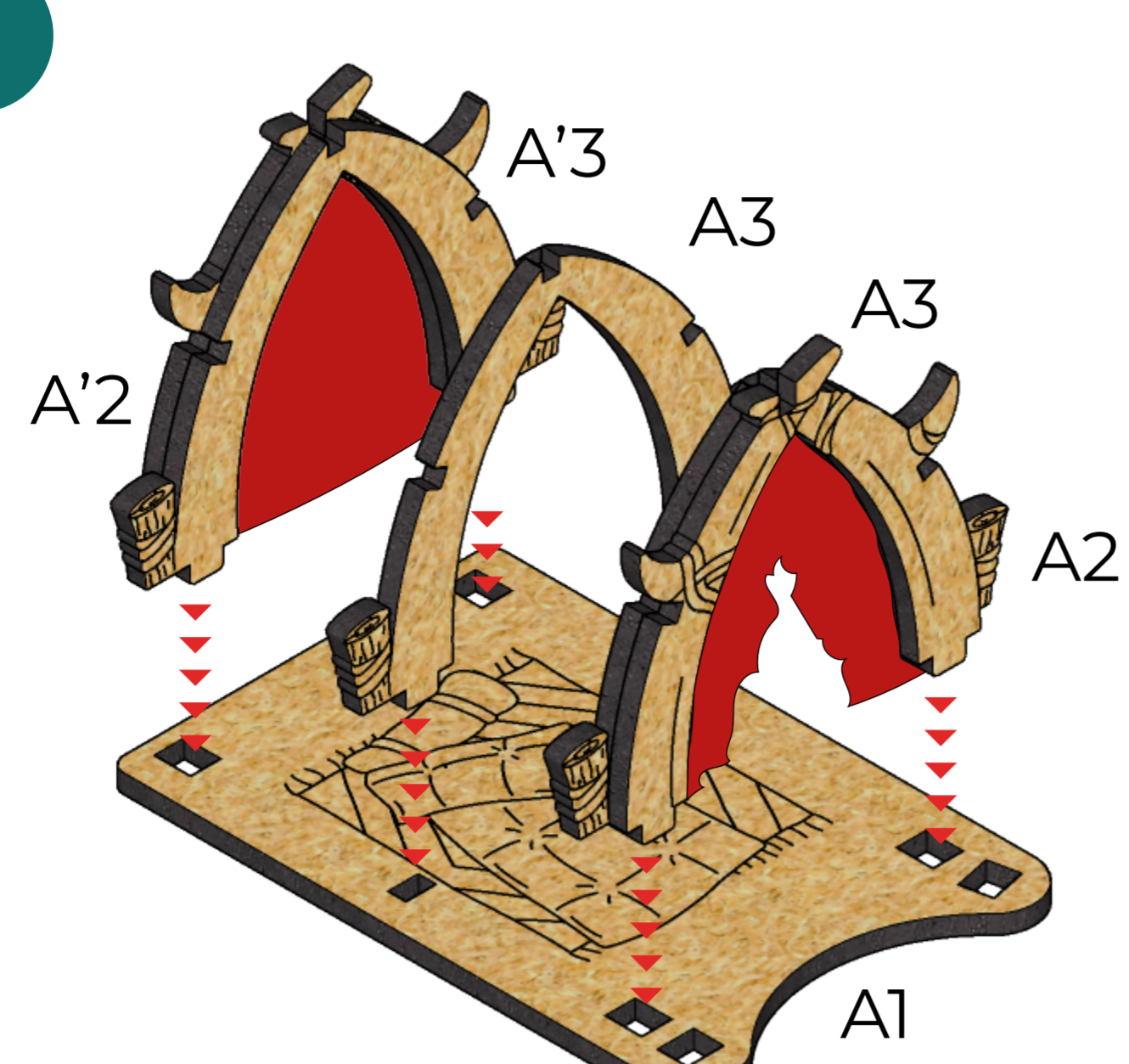

2

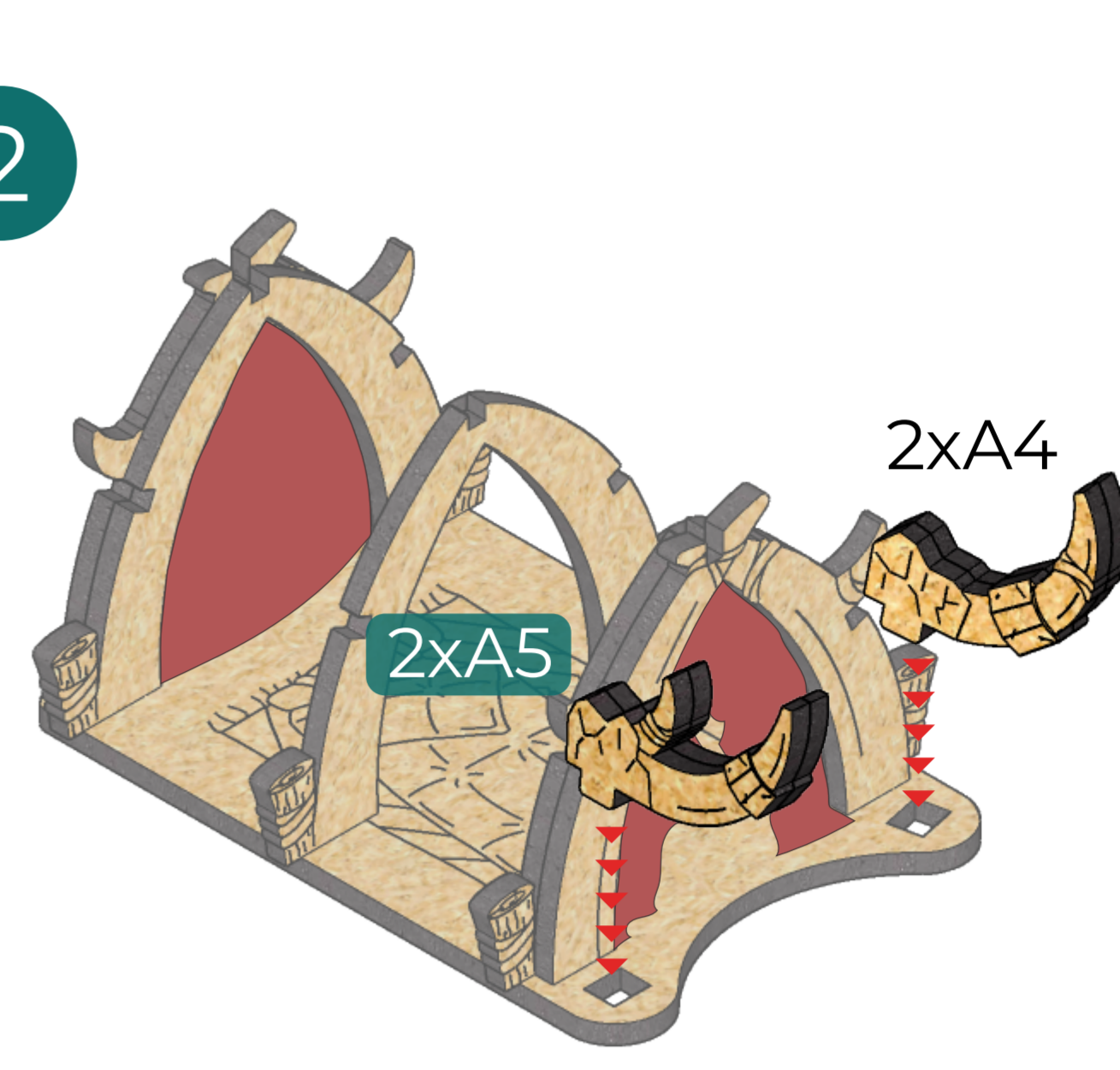

3

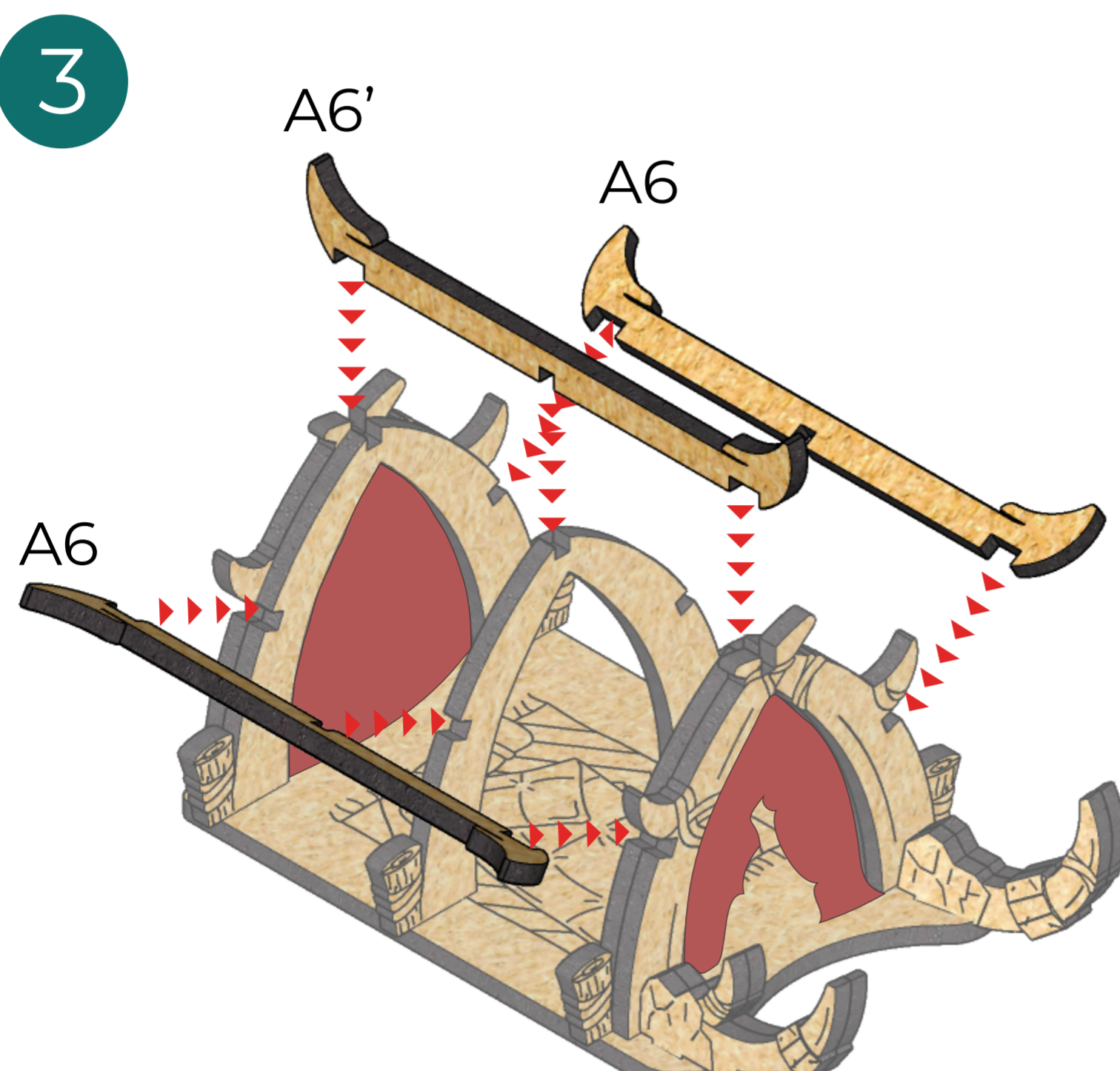

4

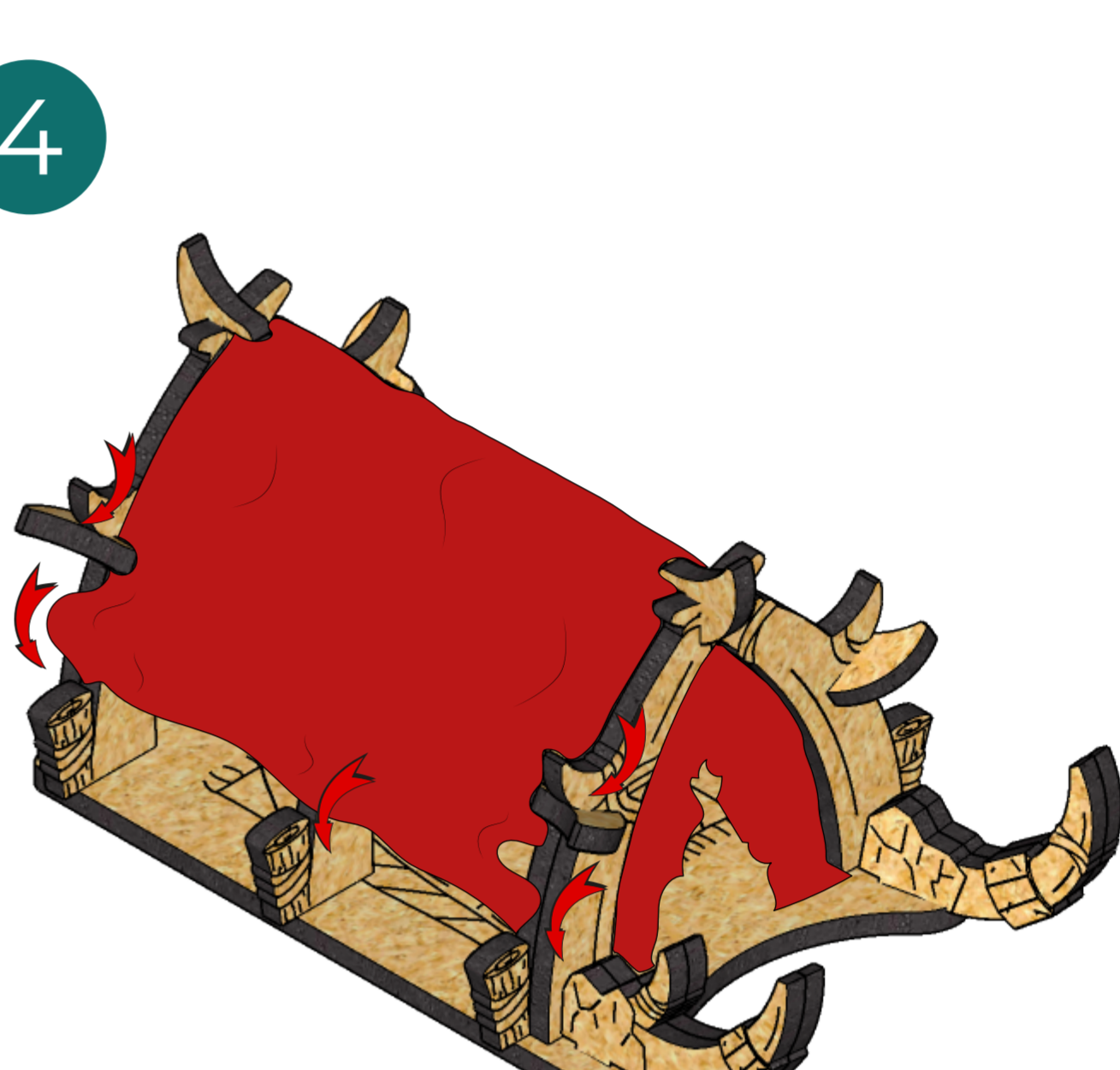

B

1

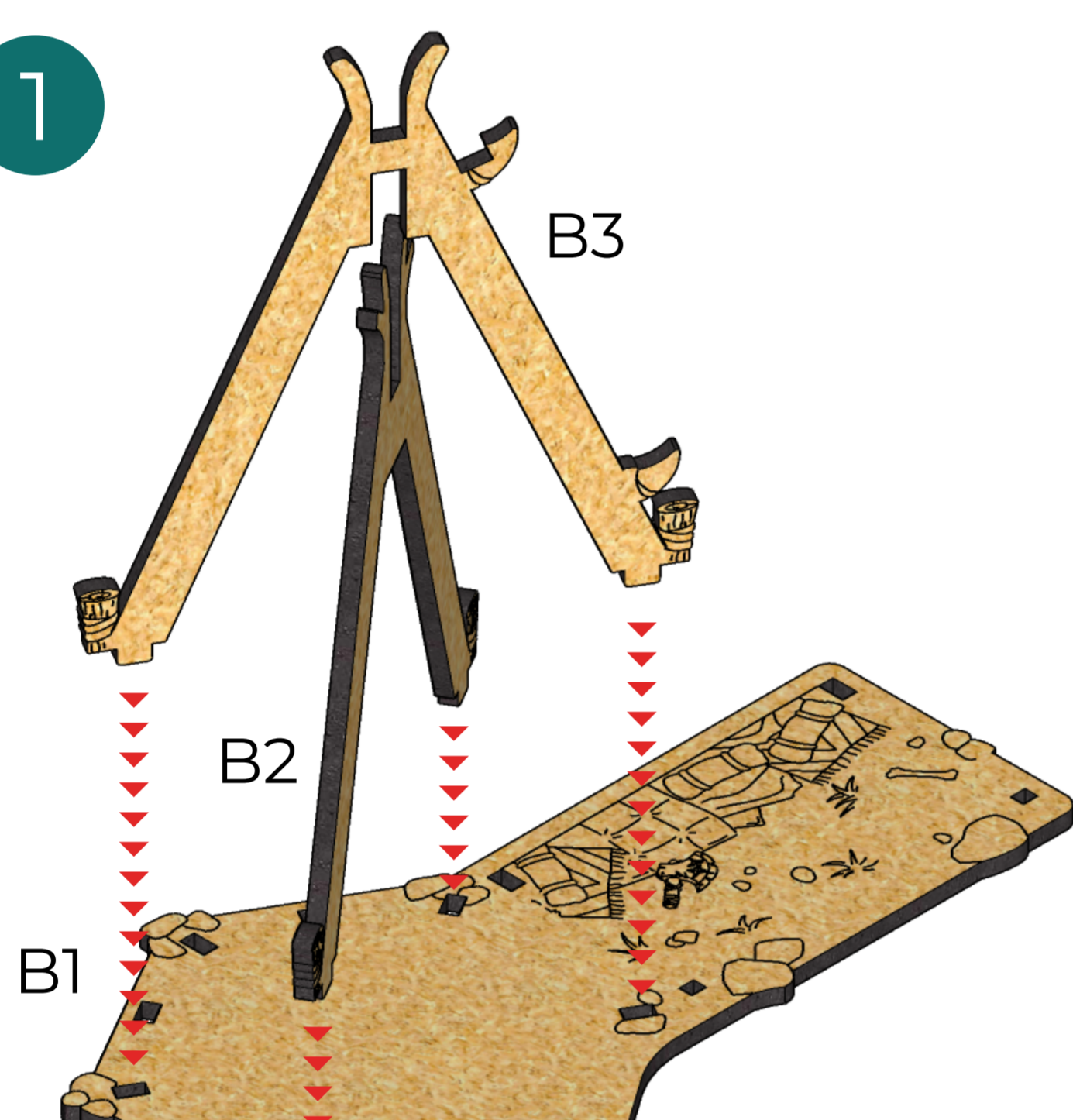

2



3

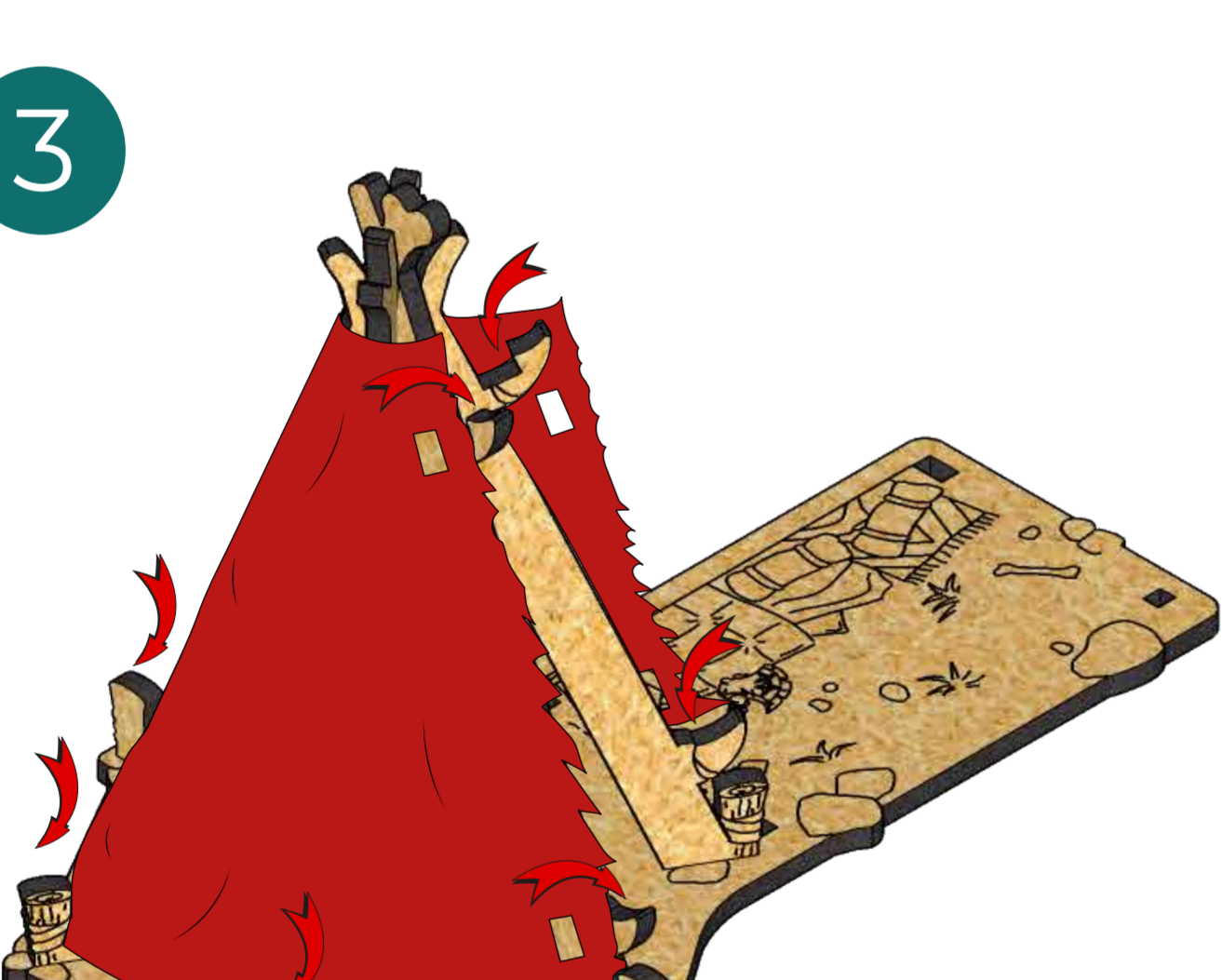

4

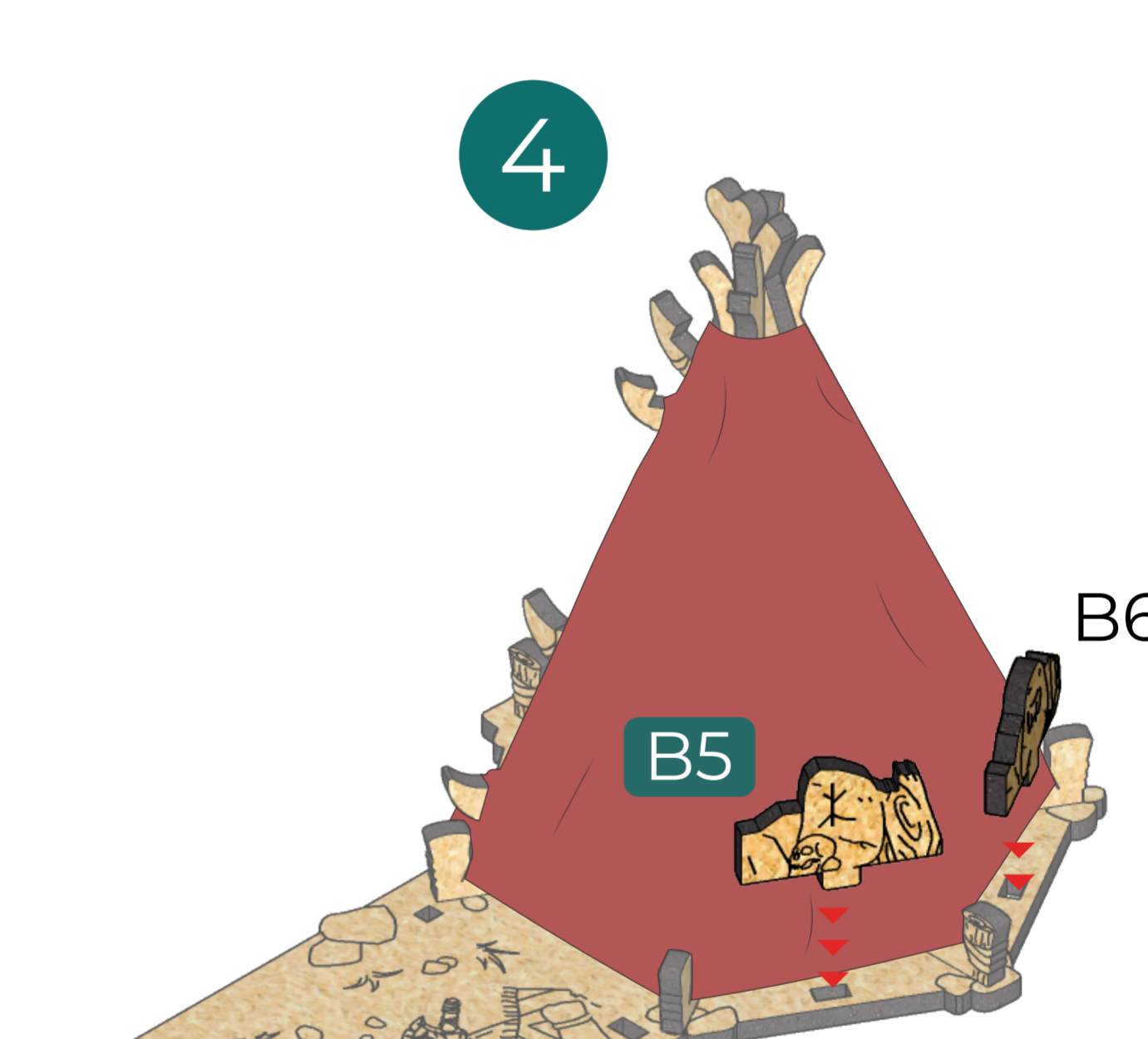

5

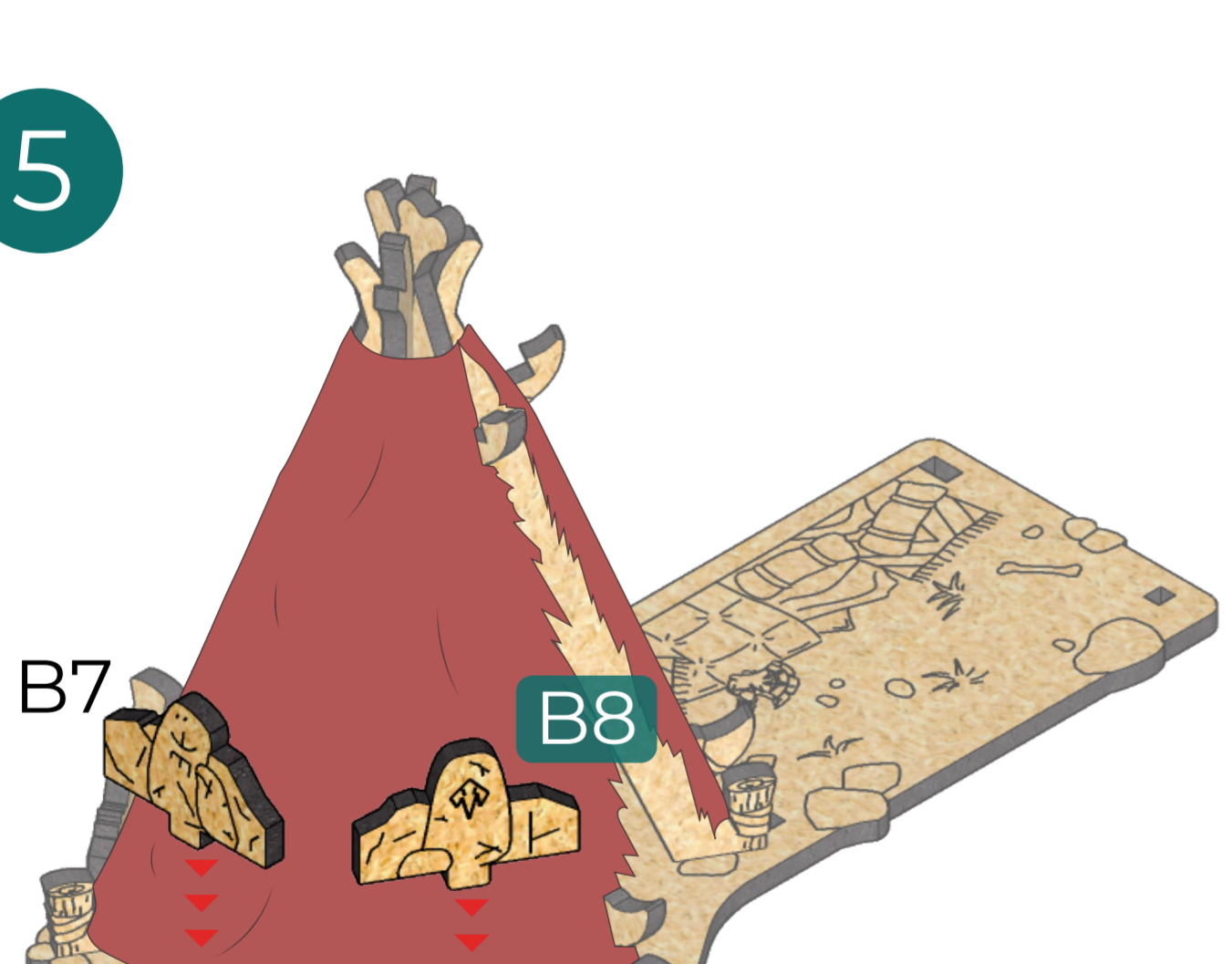

6

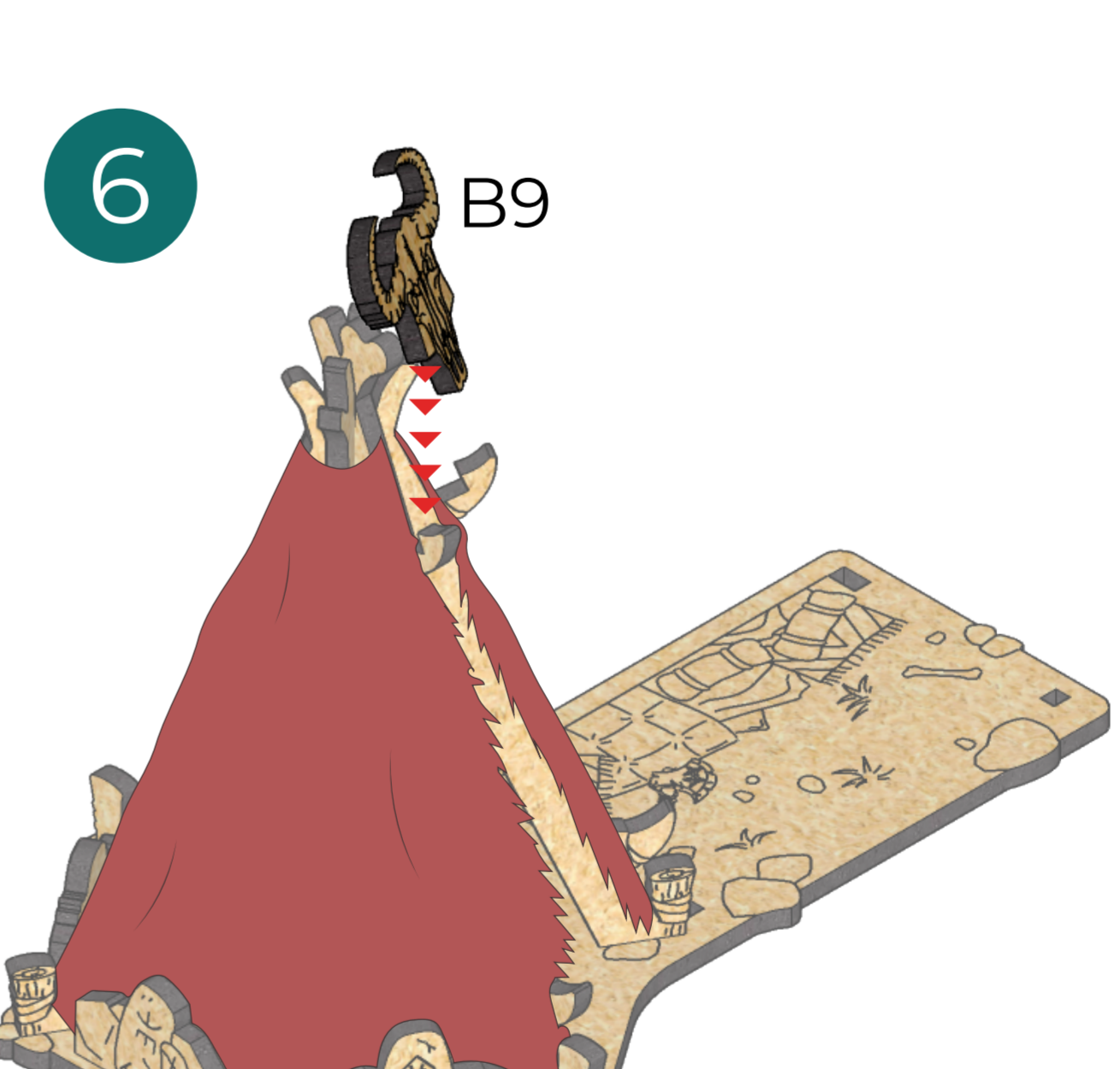

7

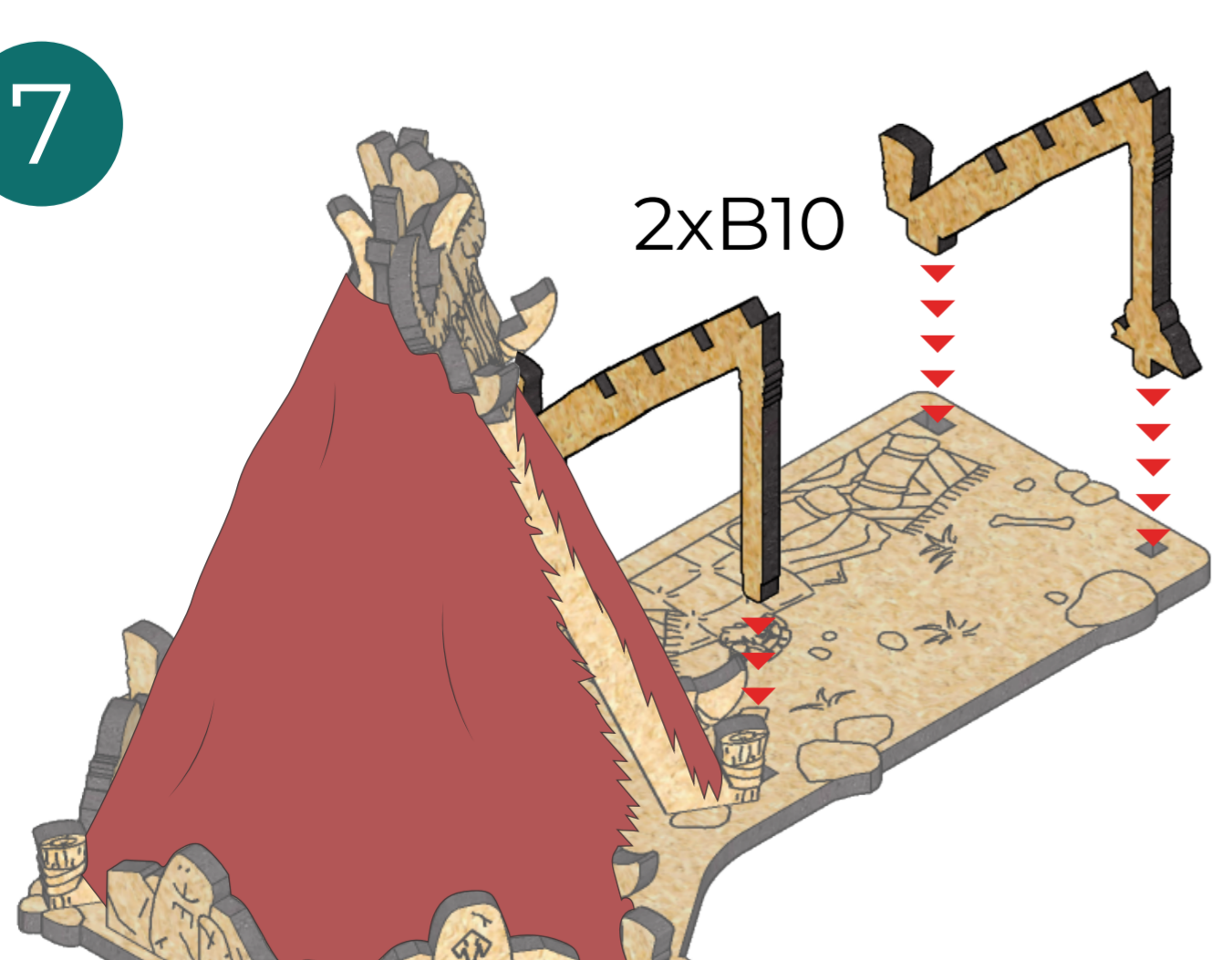

8

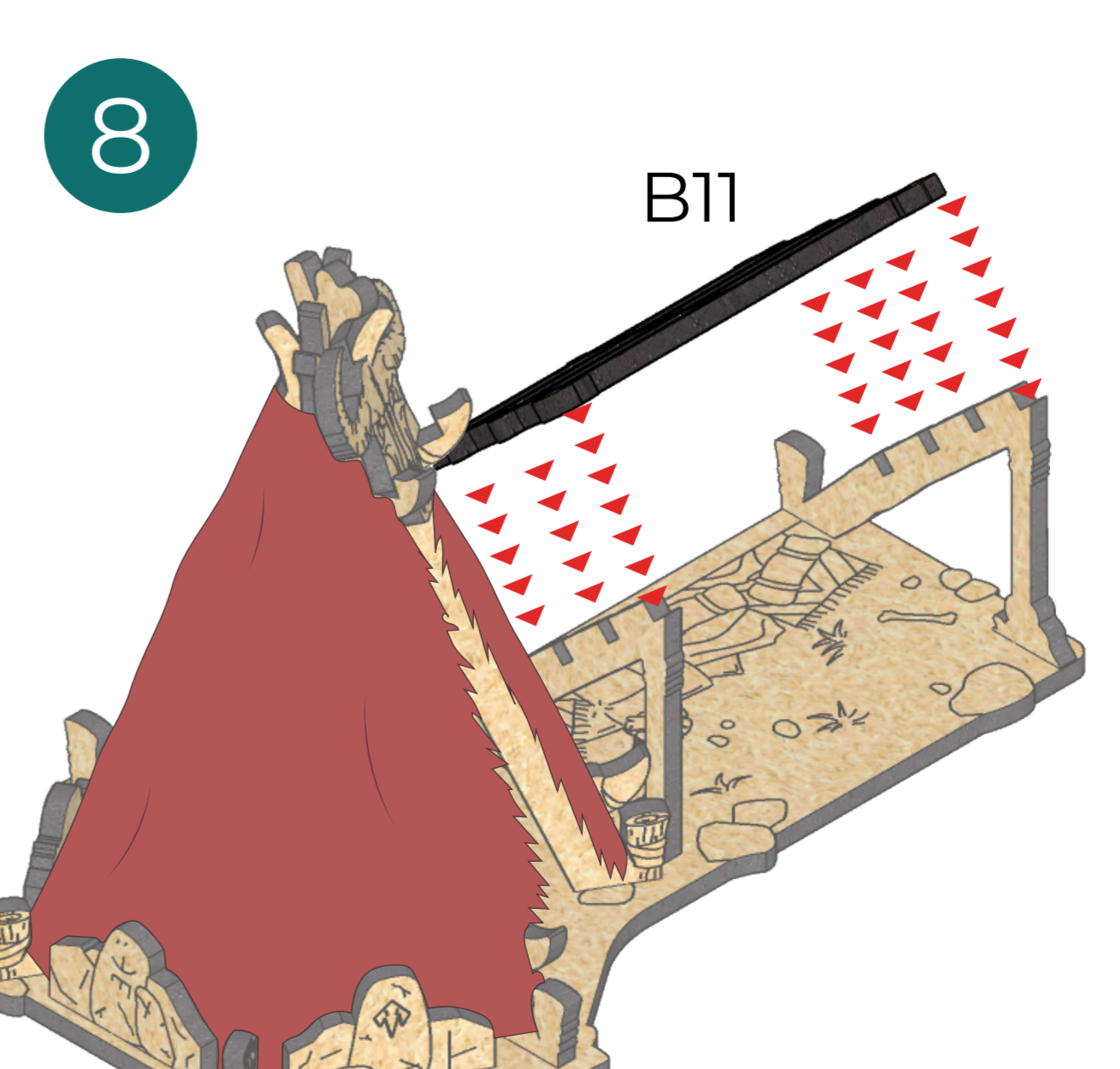

9

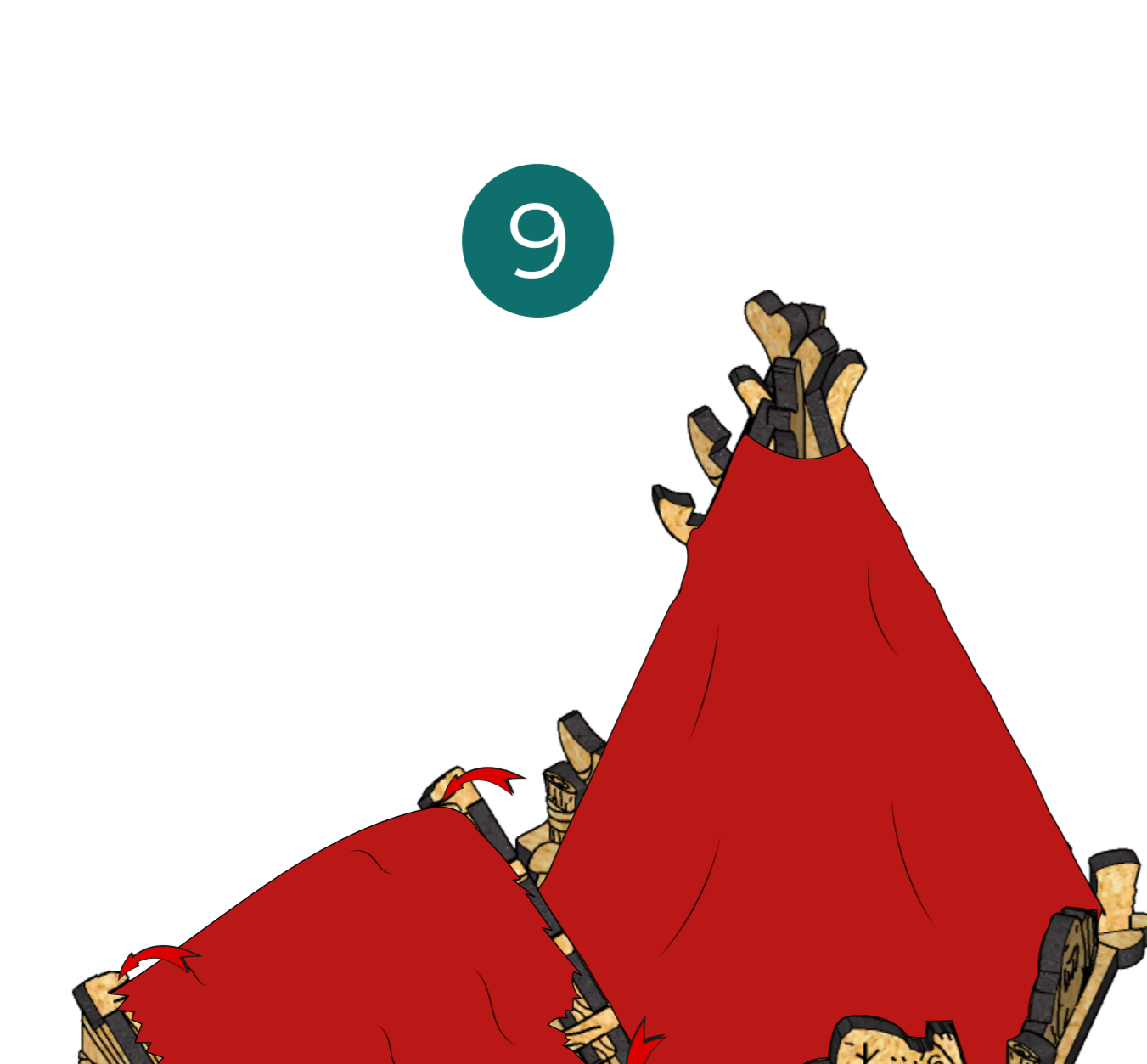

C

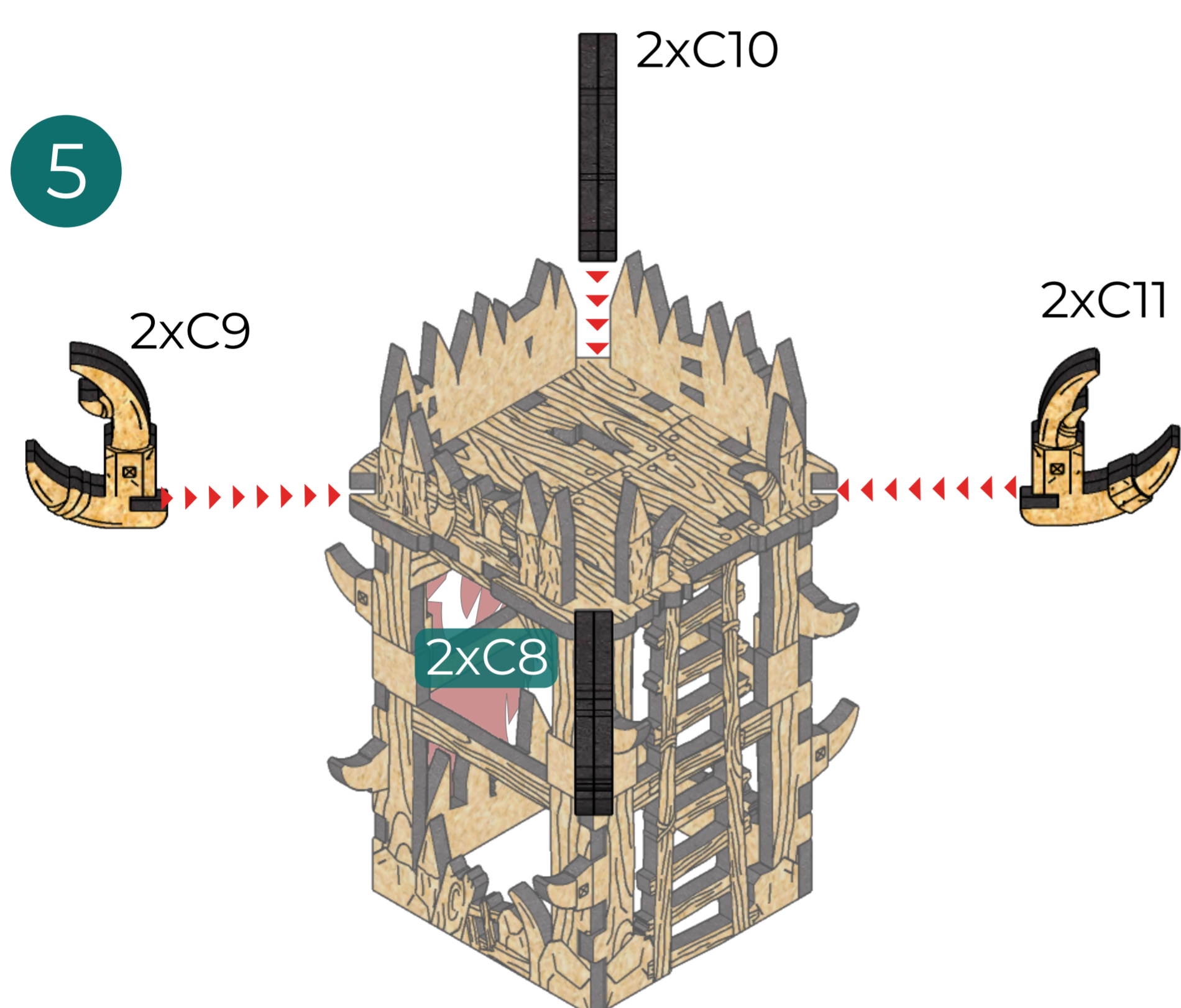
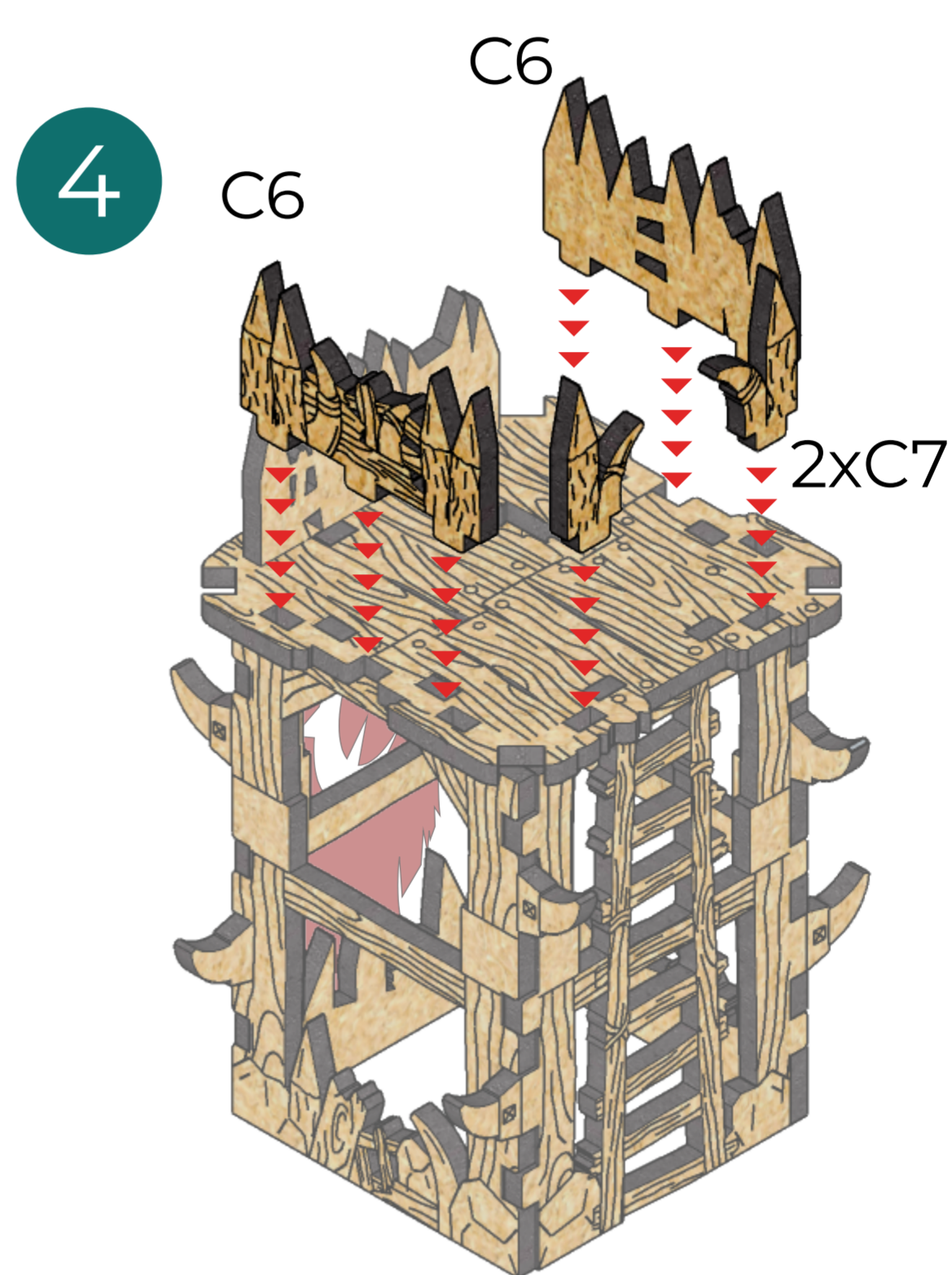
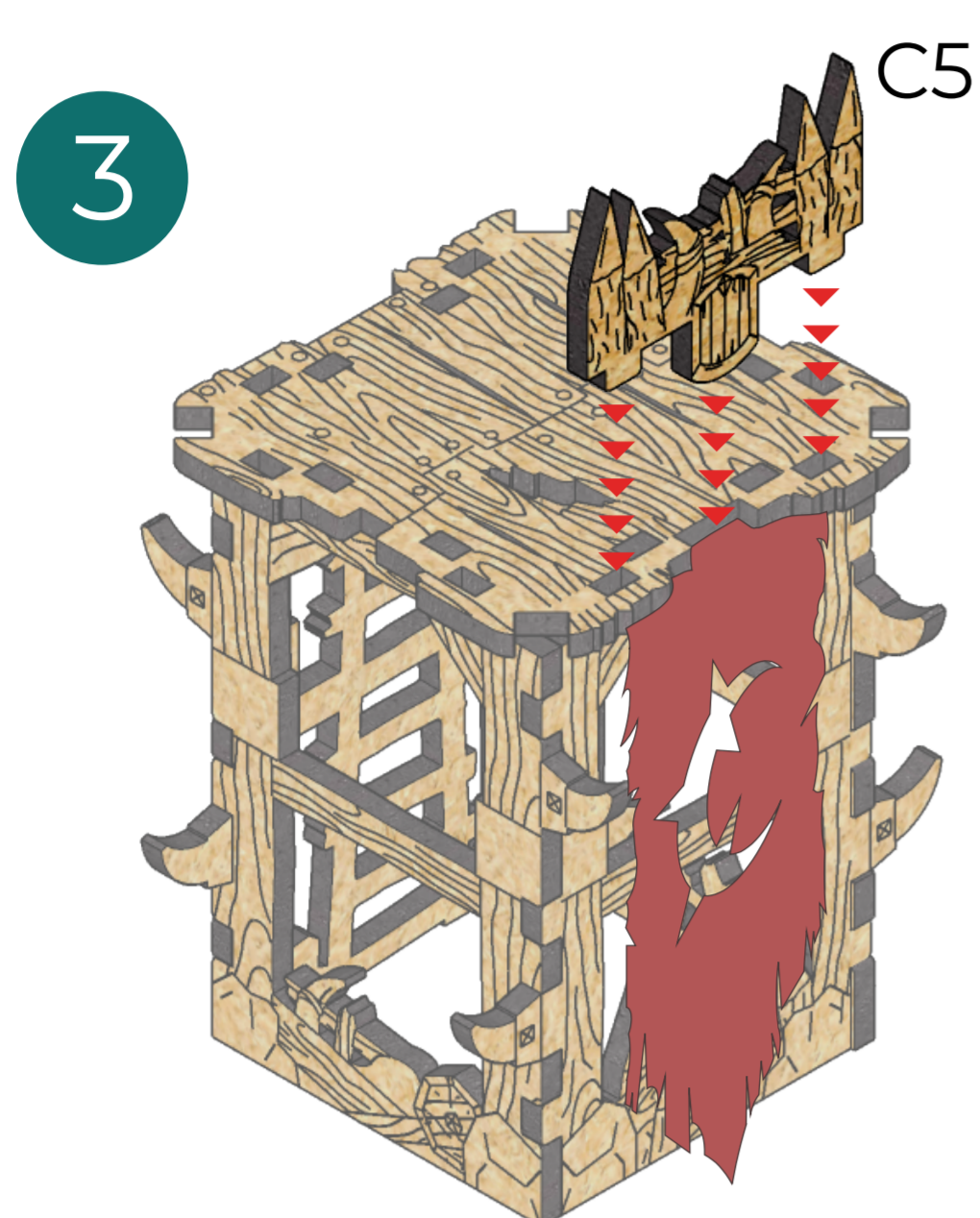
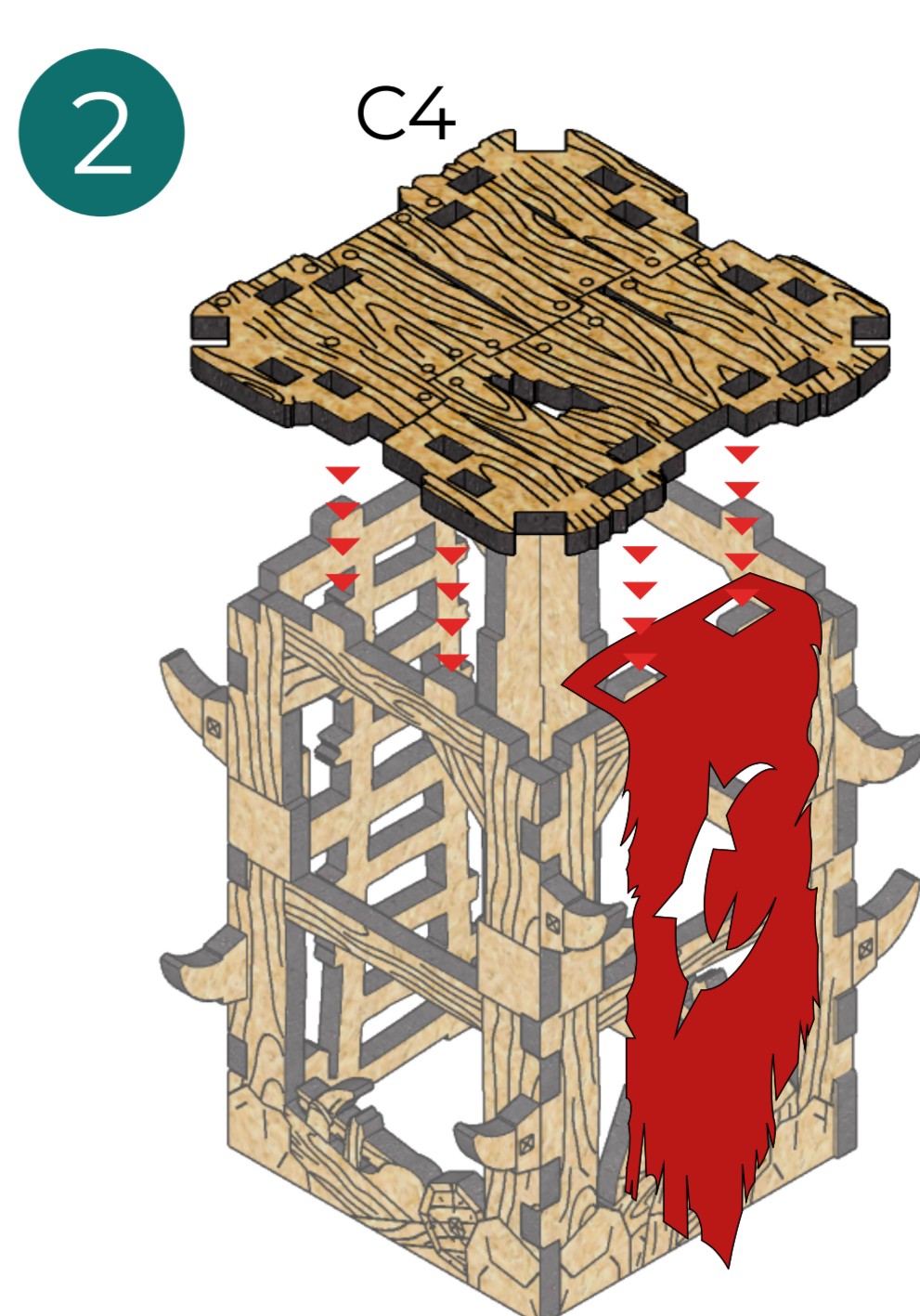
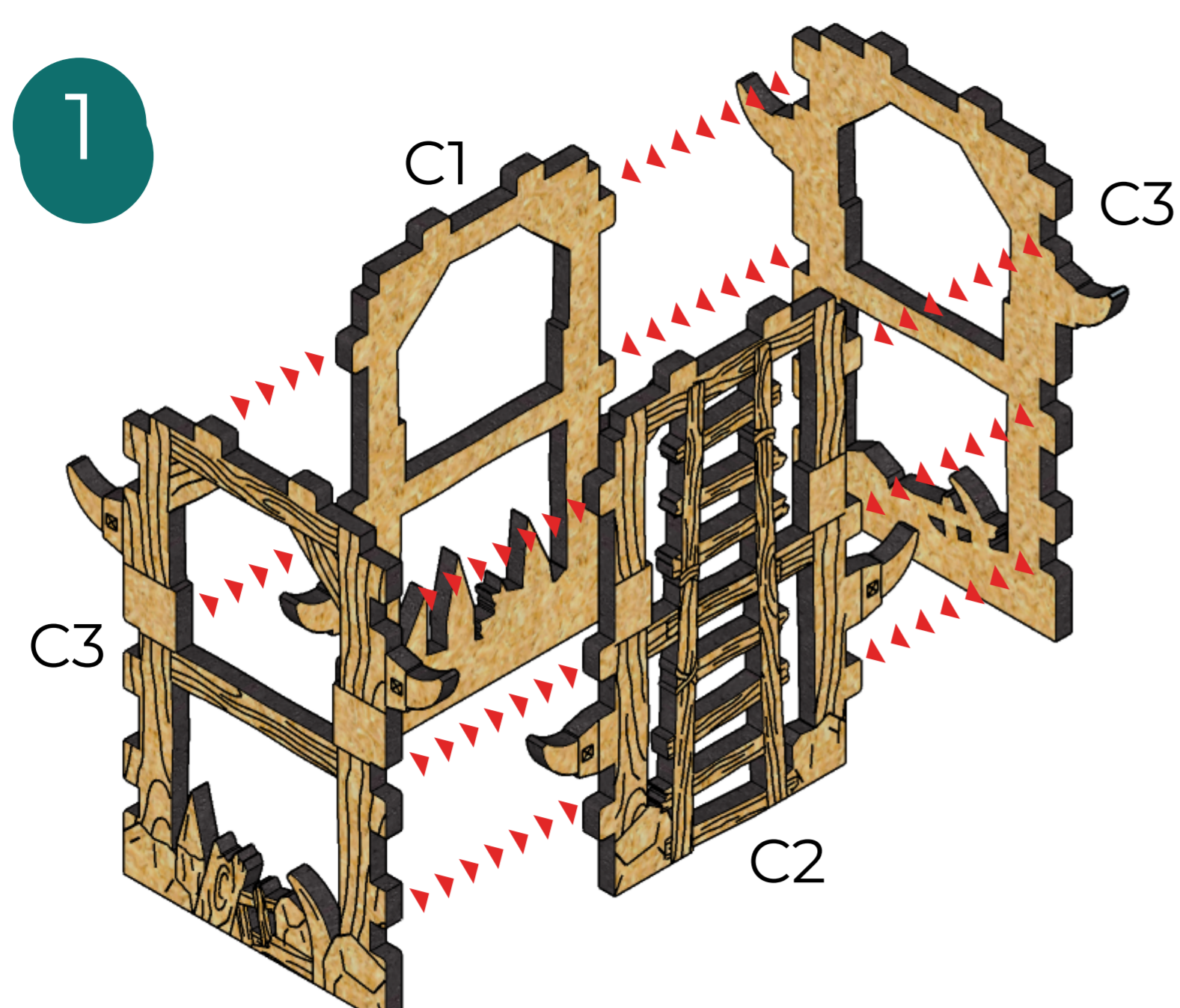

D

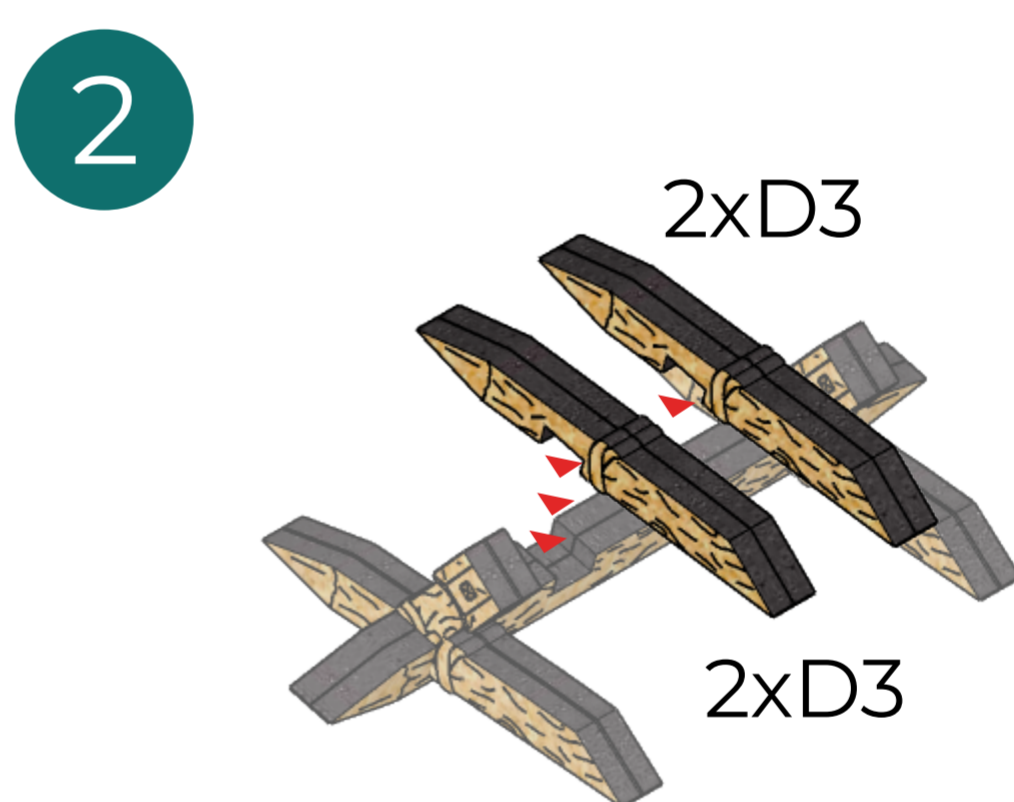
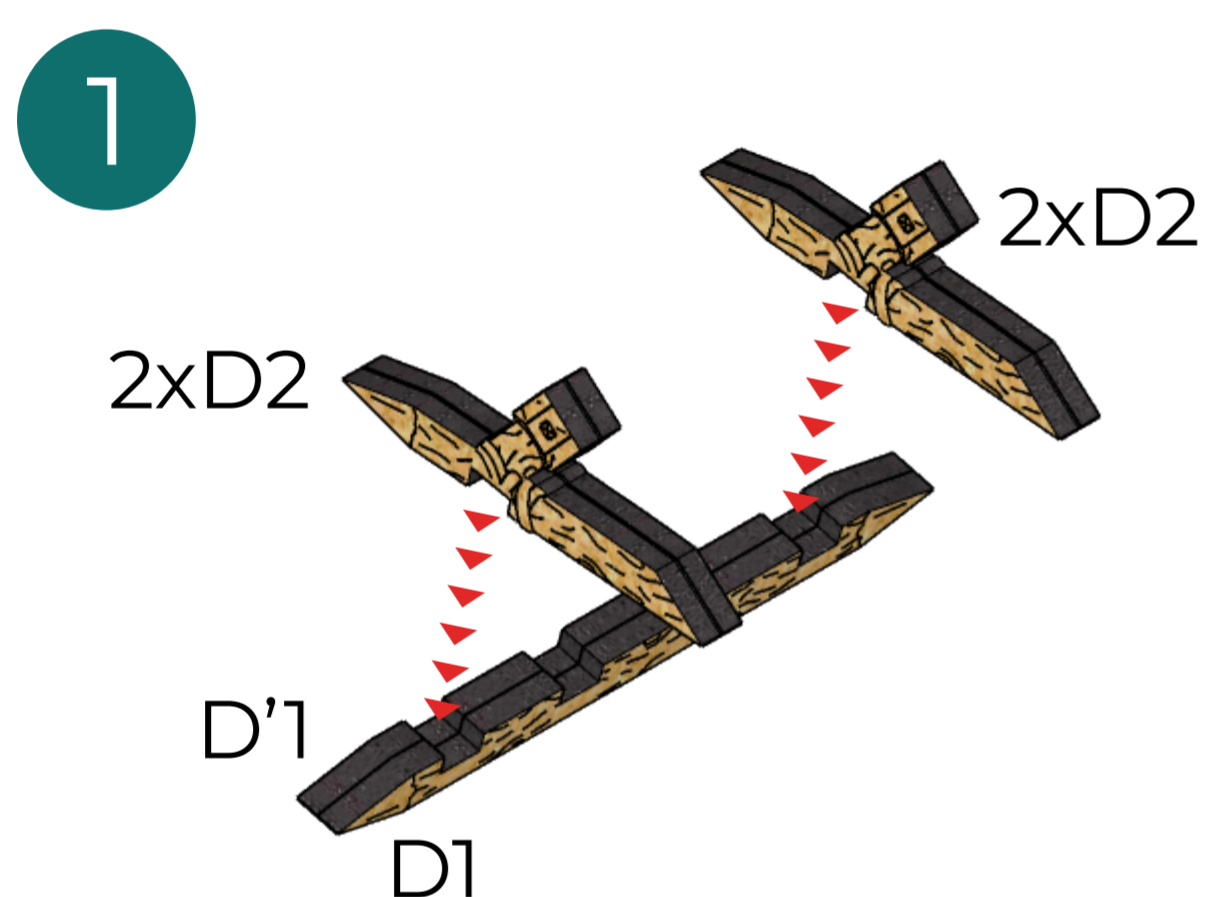

E

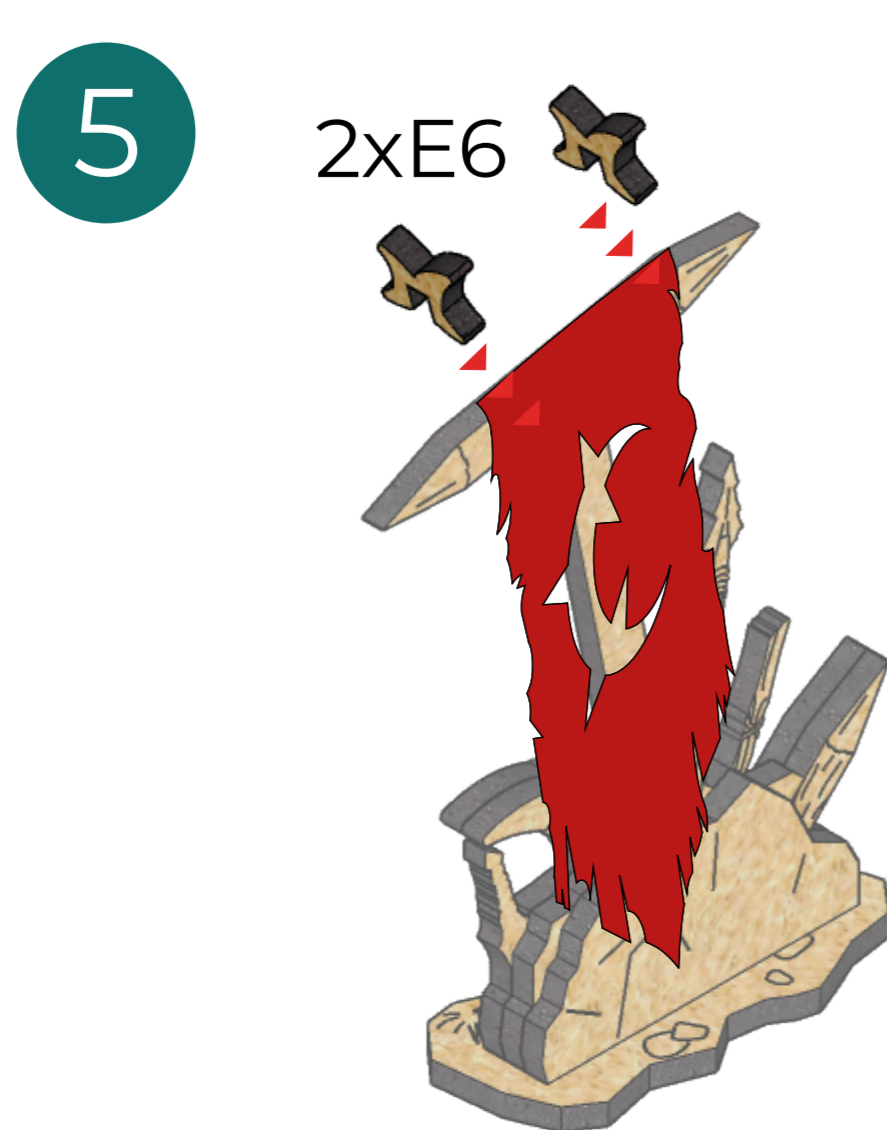
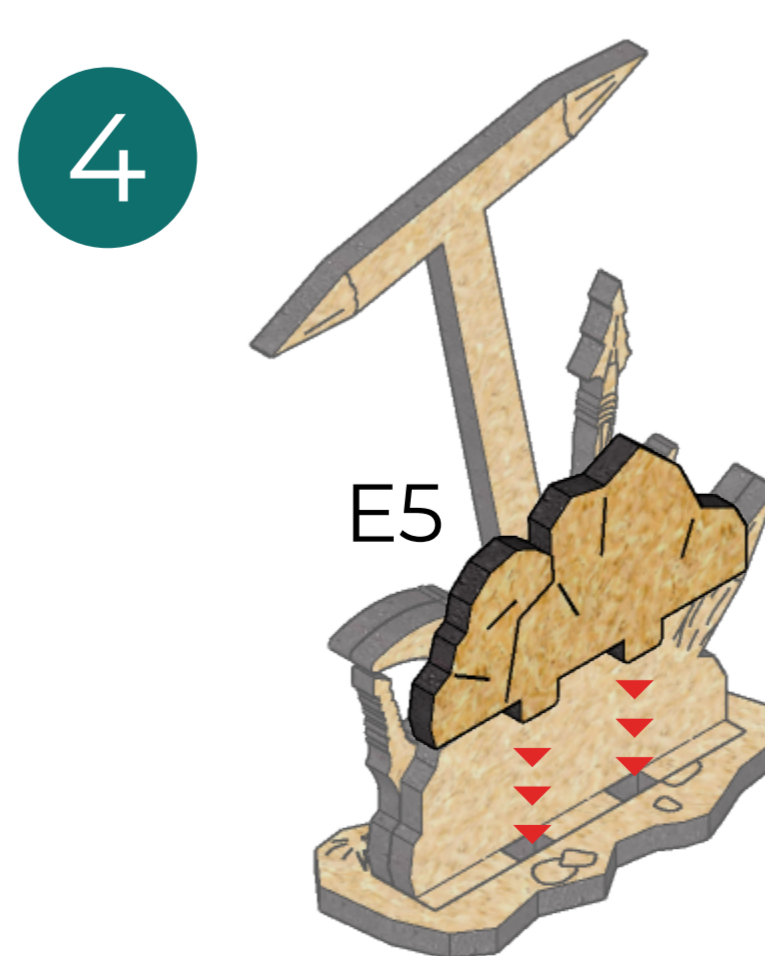
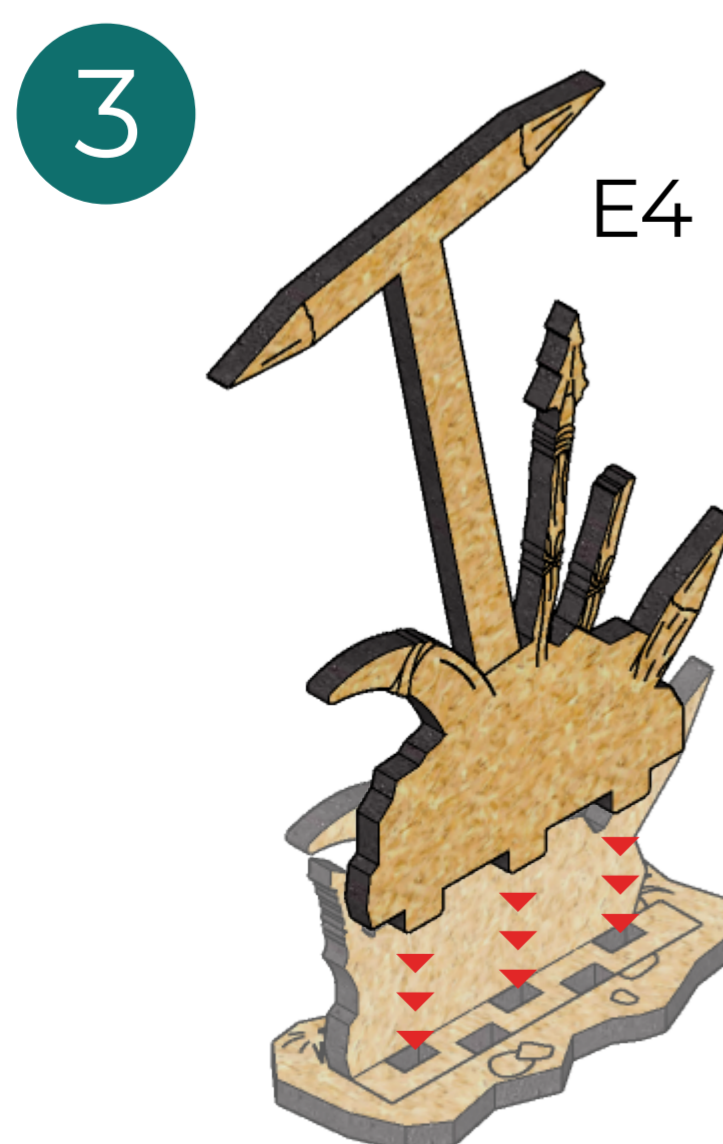
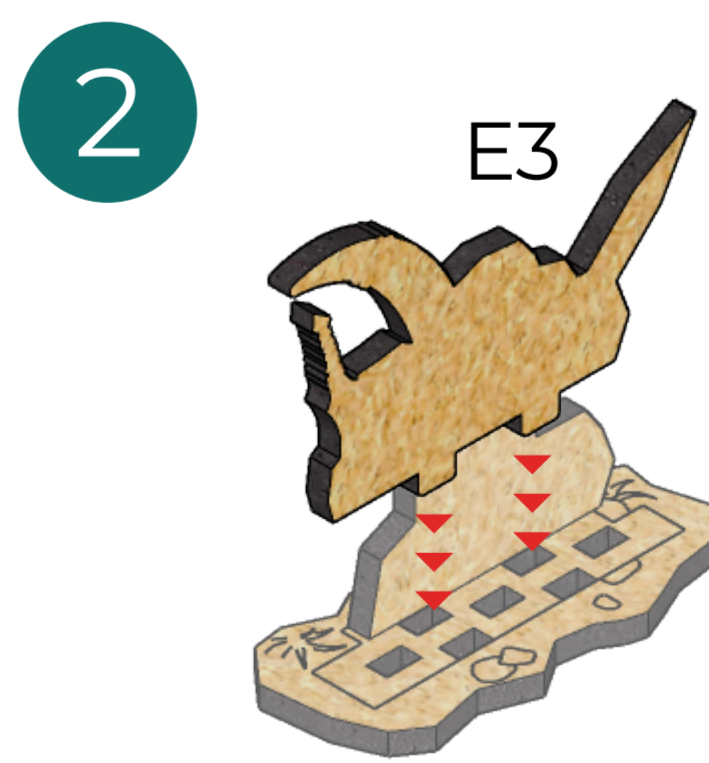
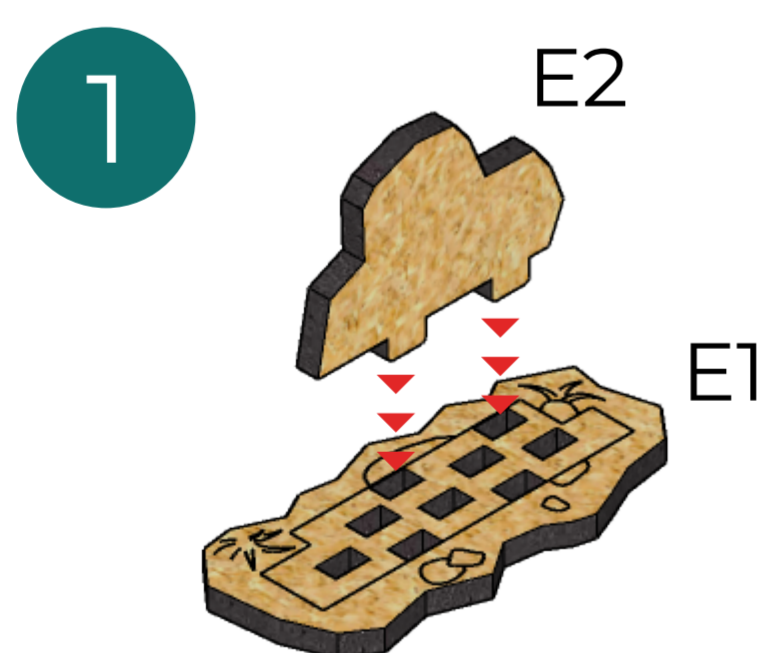

F

1

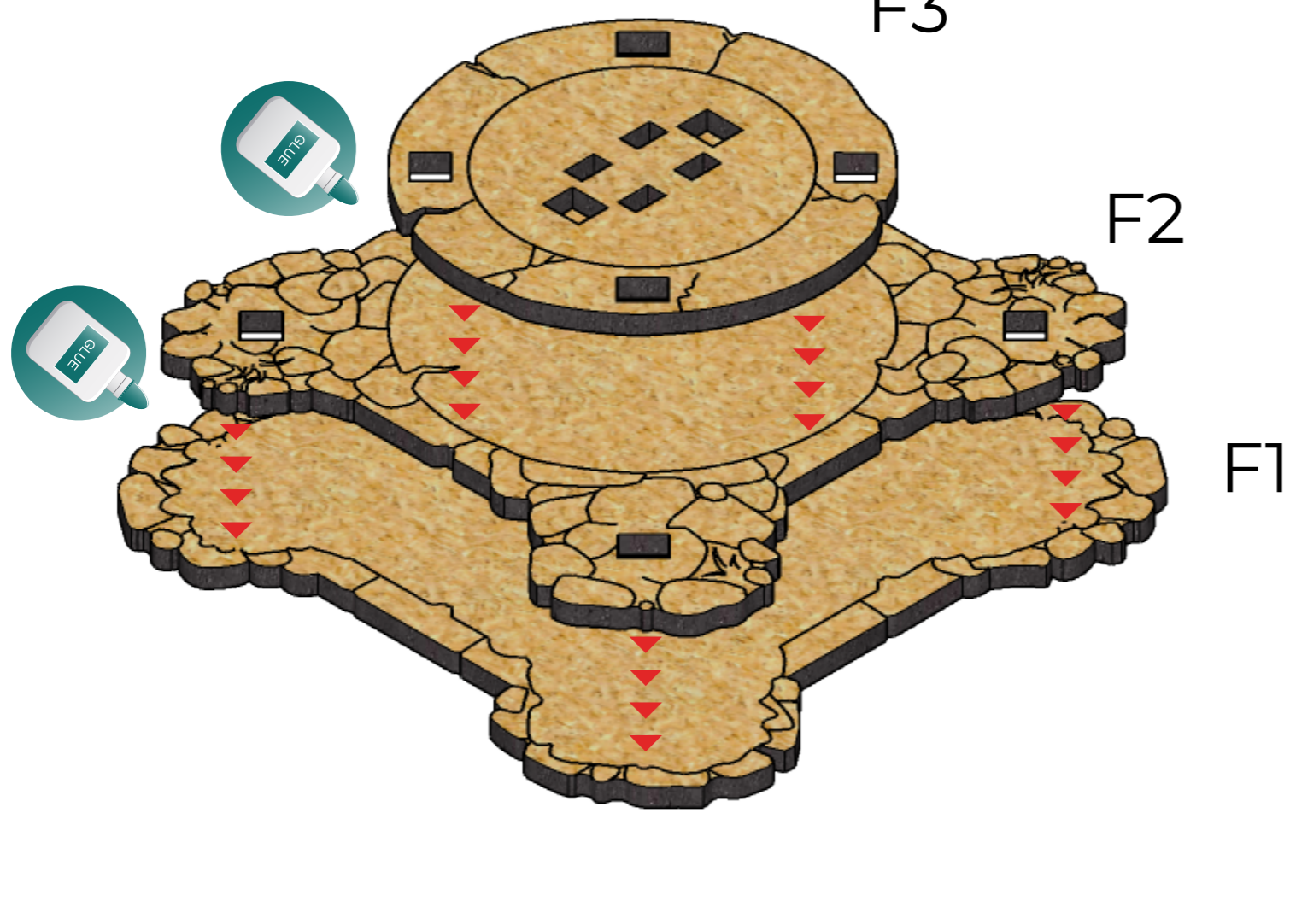

2

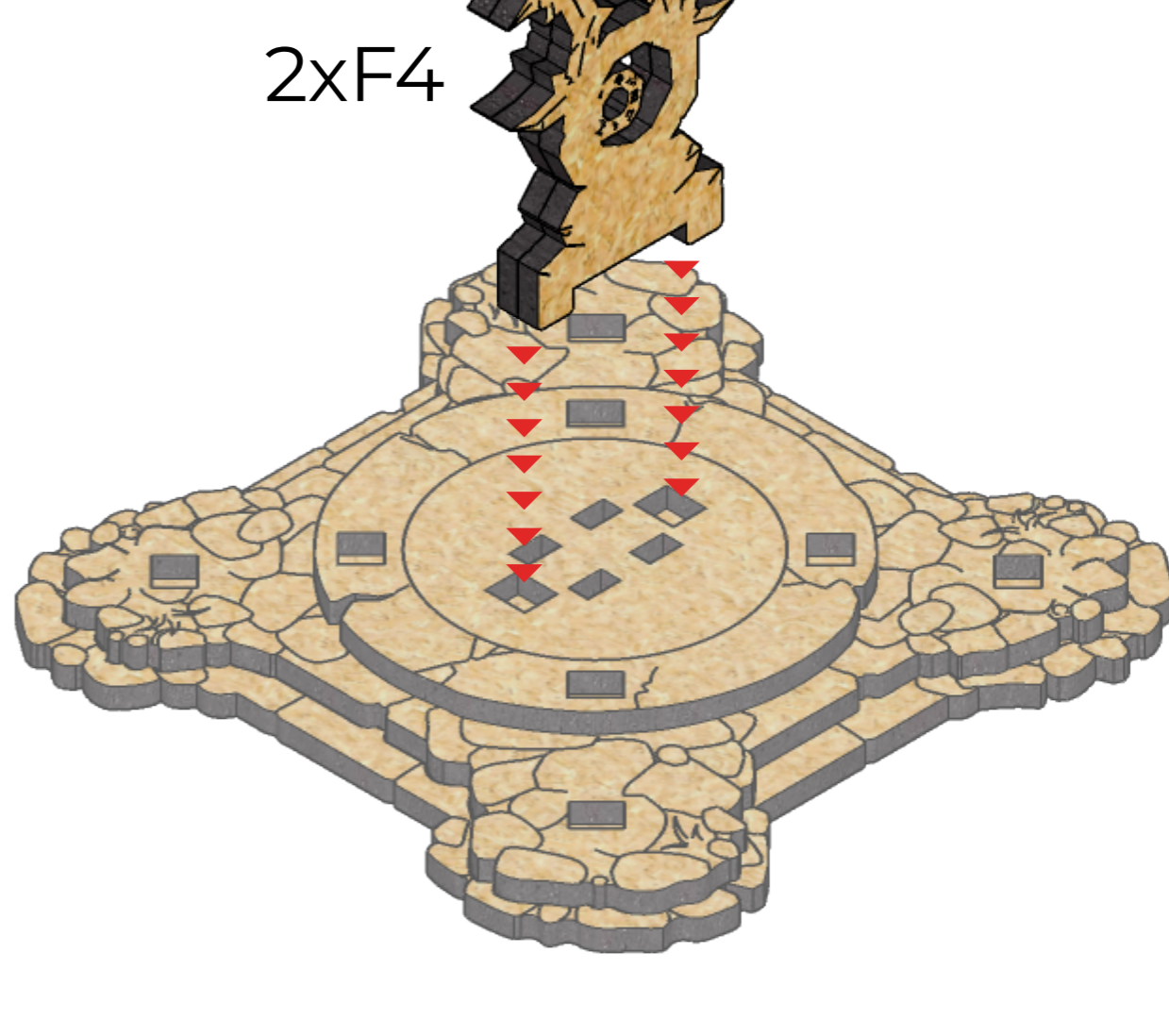

3

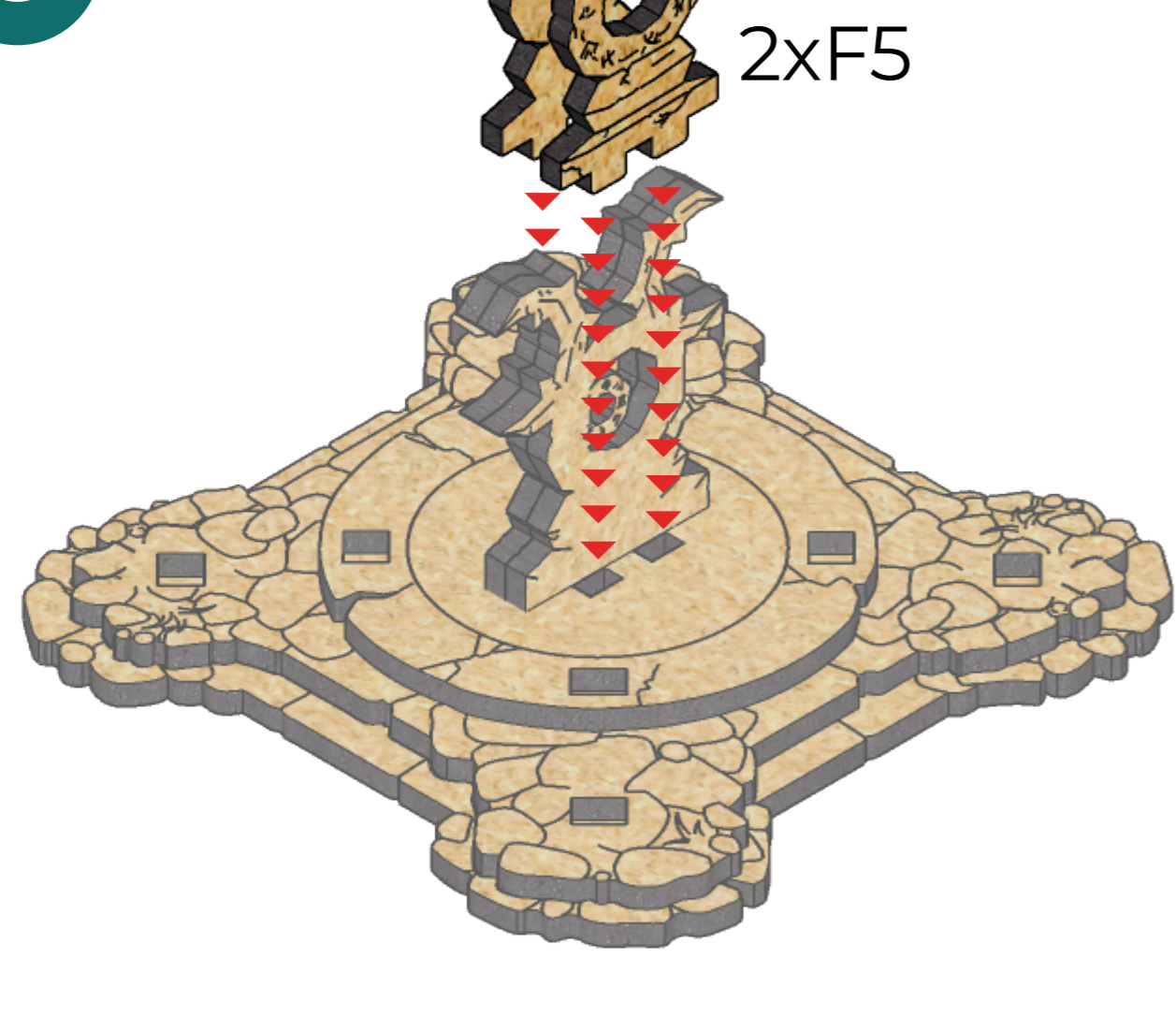

4

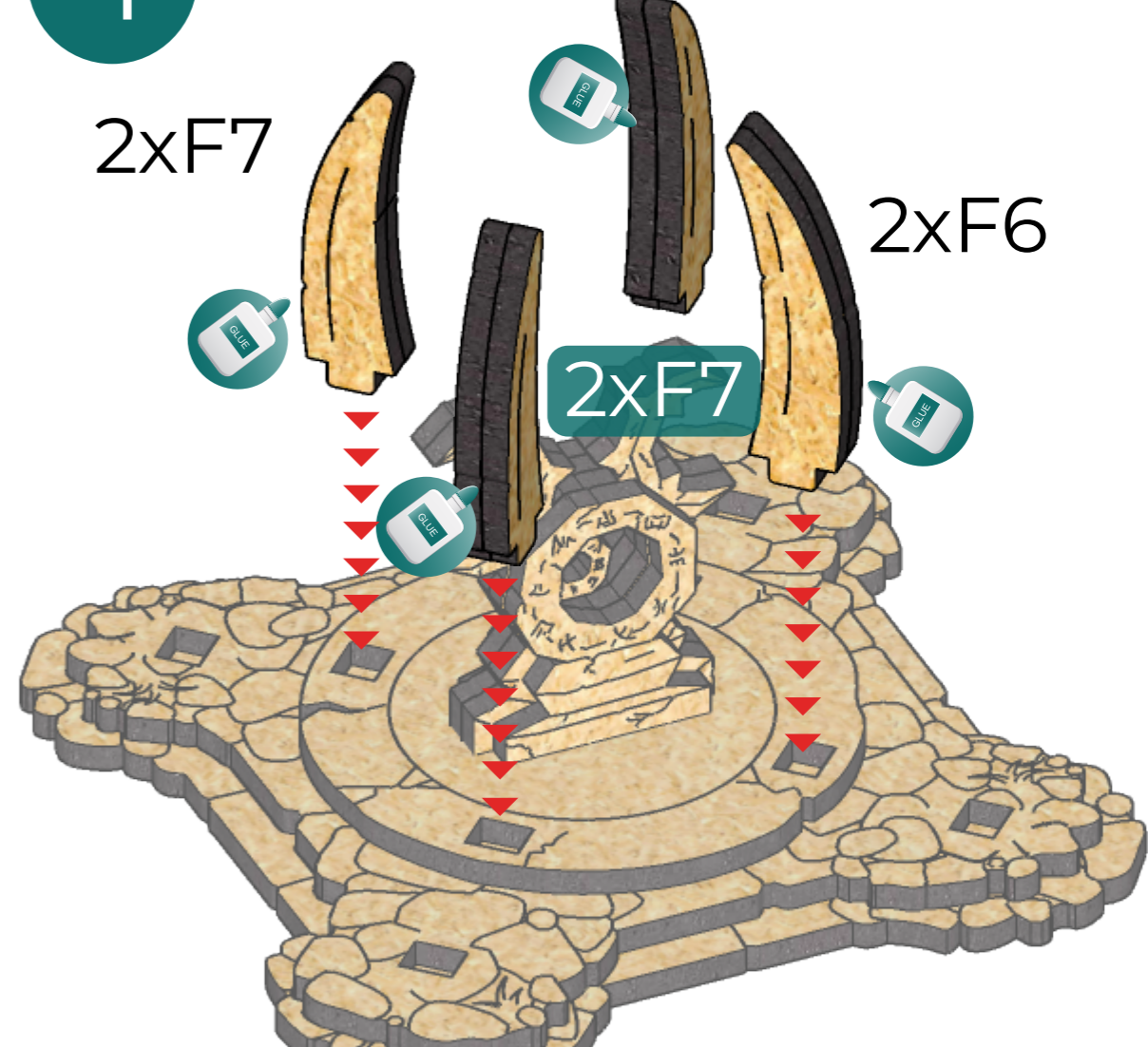

5

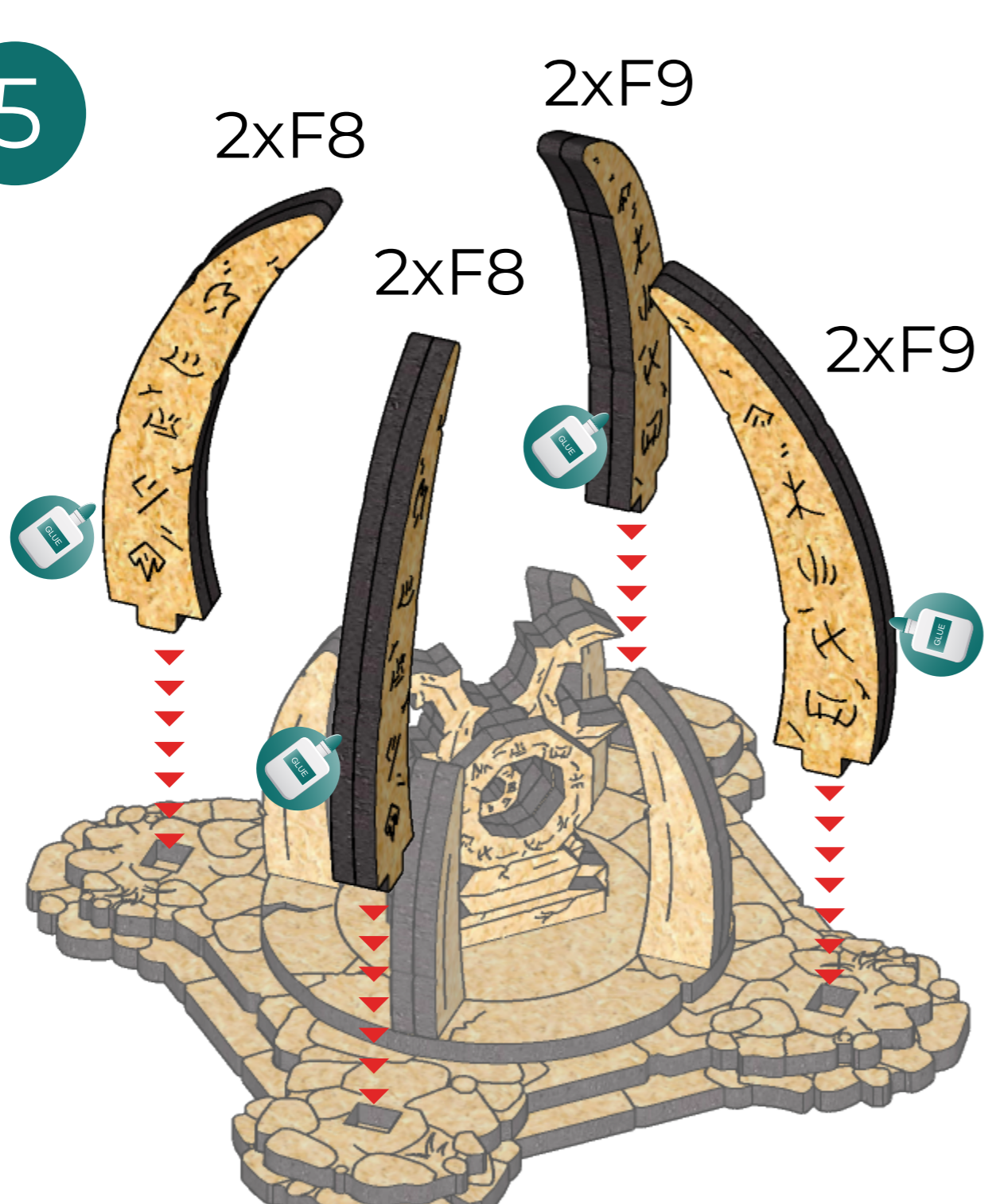

G

1

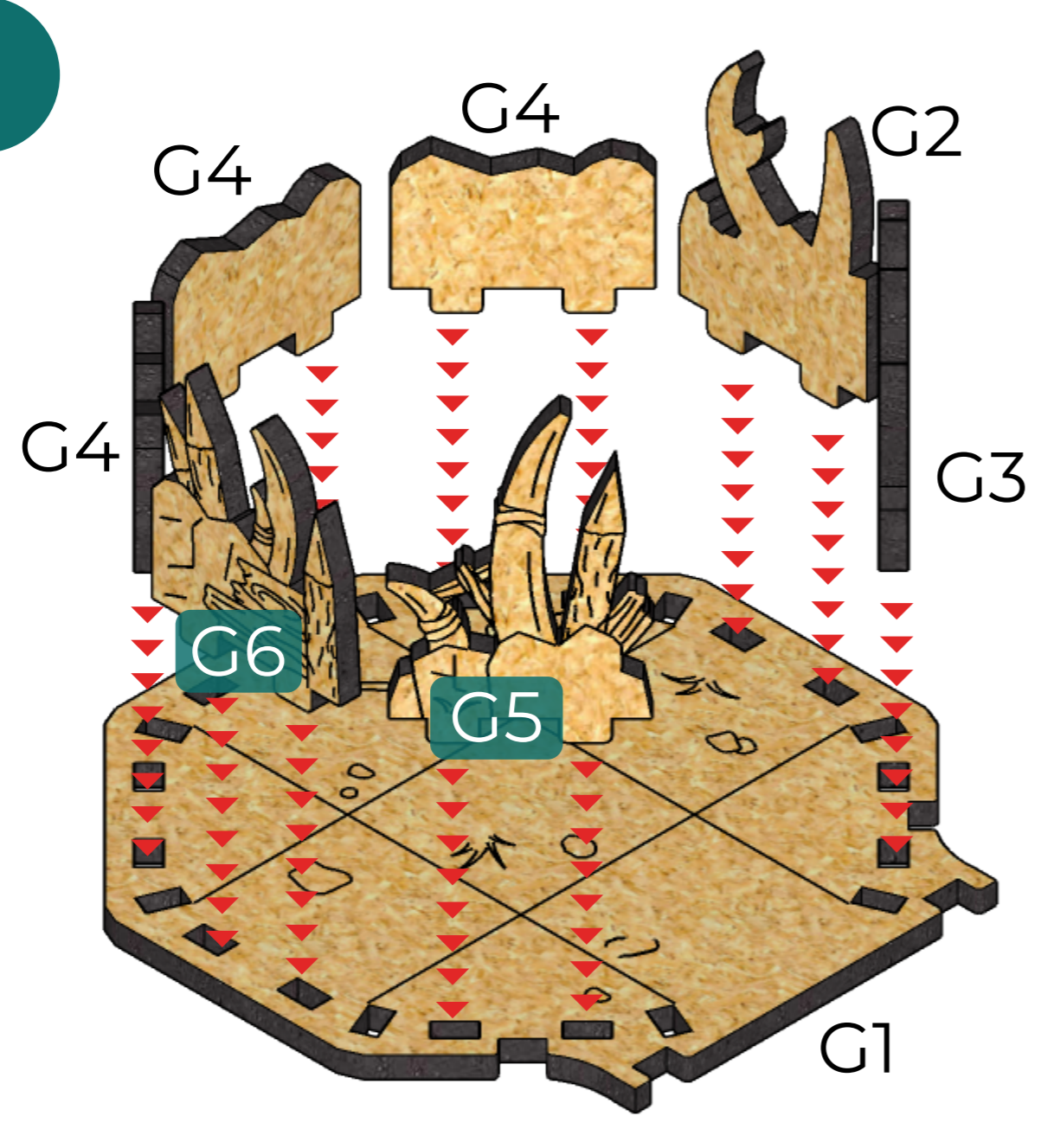

2

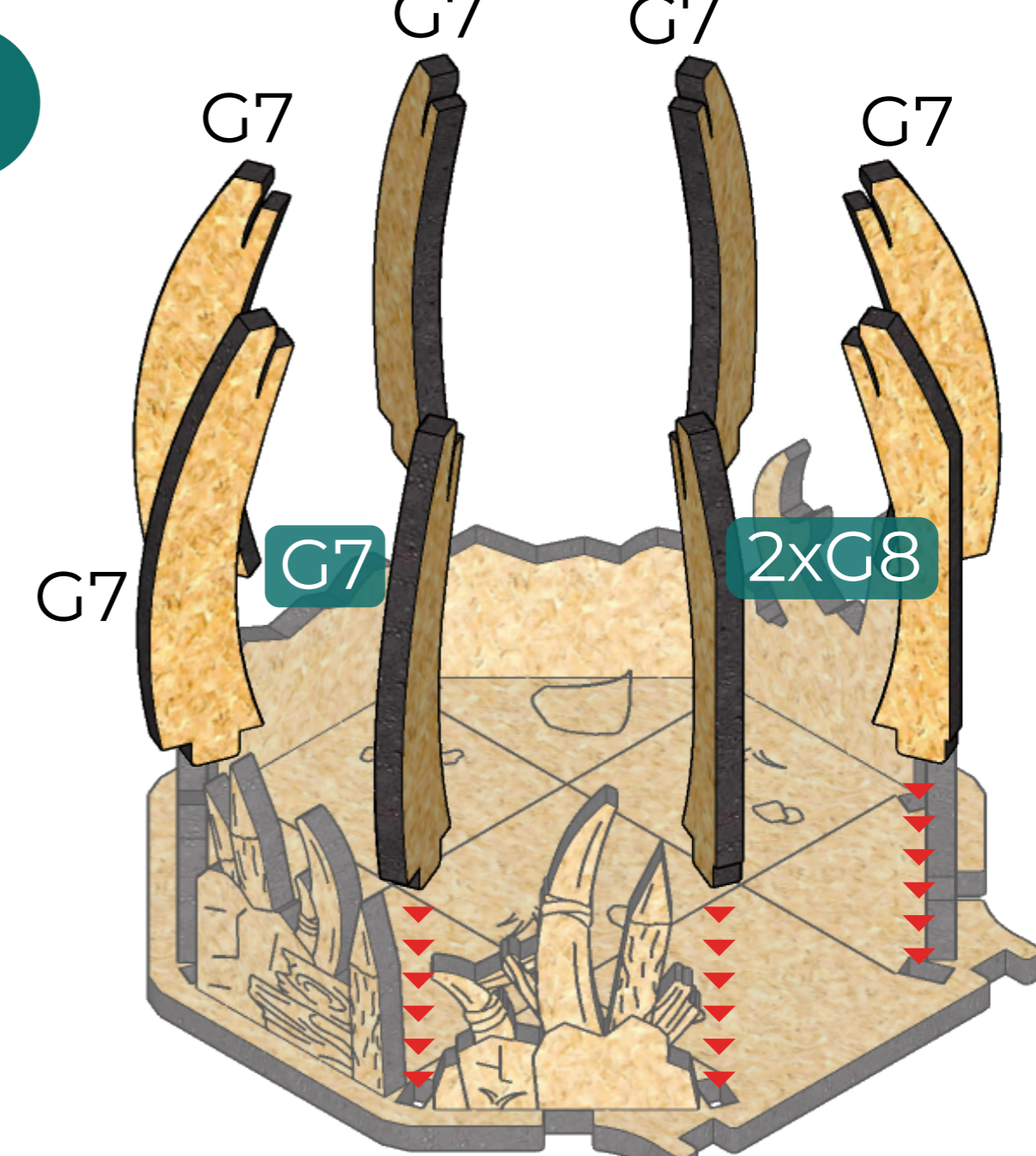

3

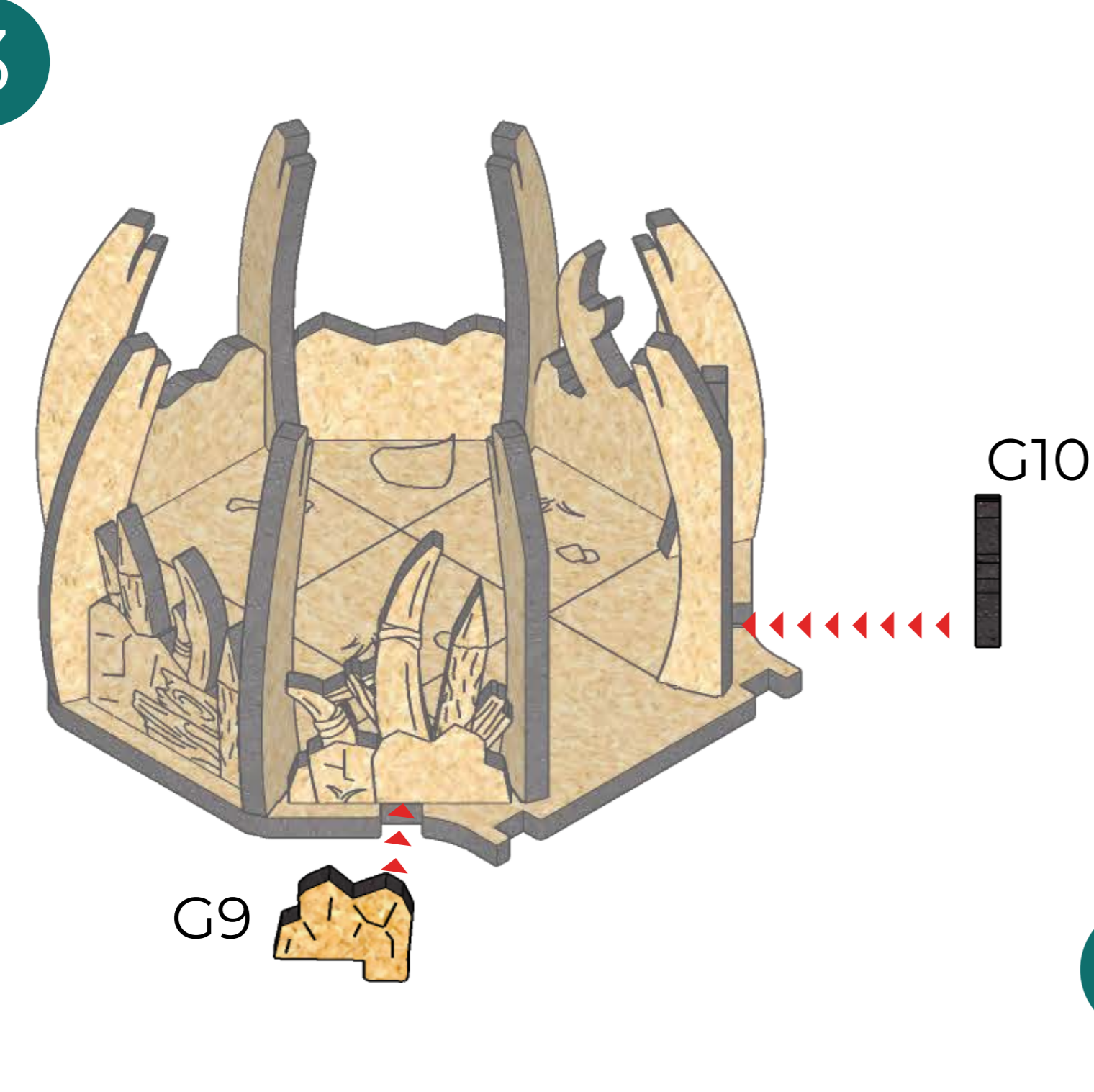

4

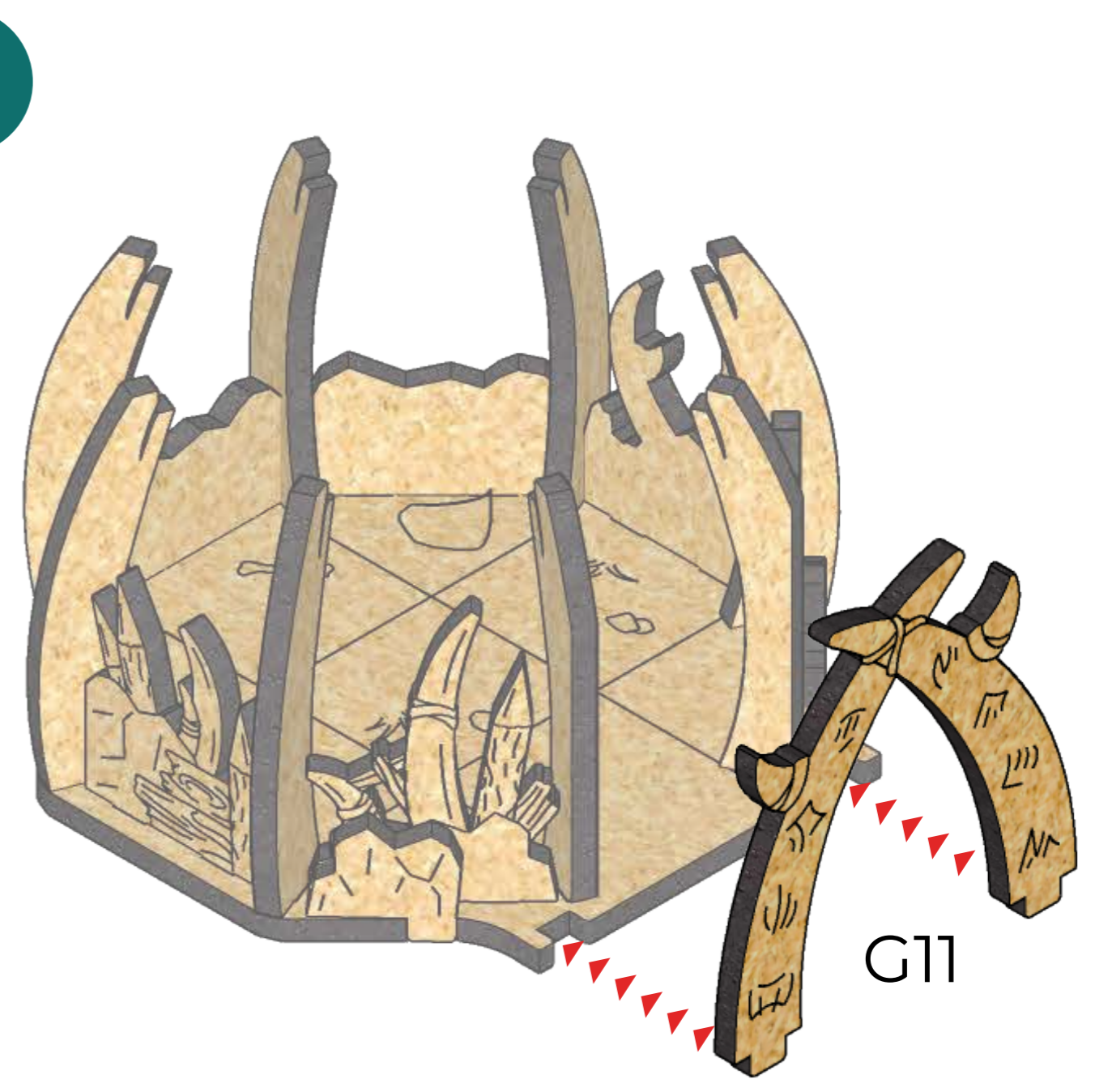

5

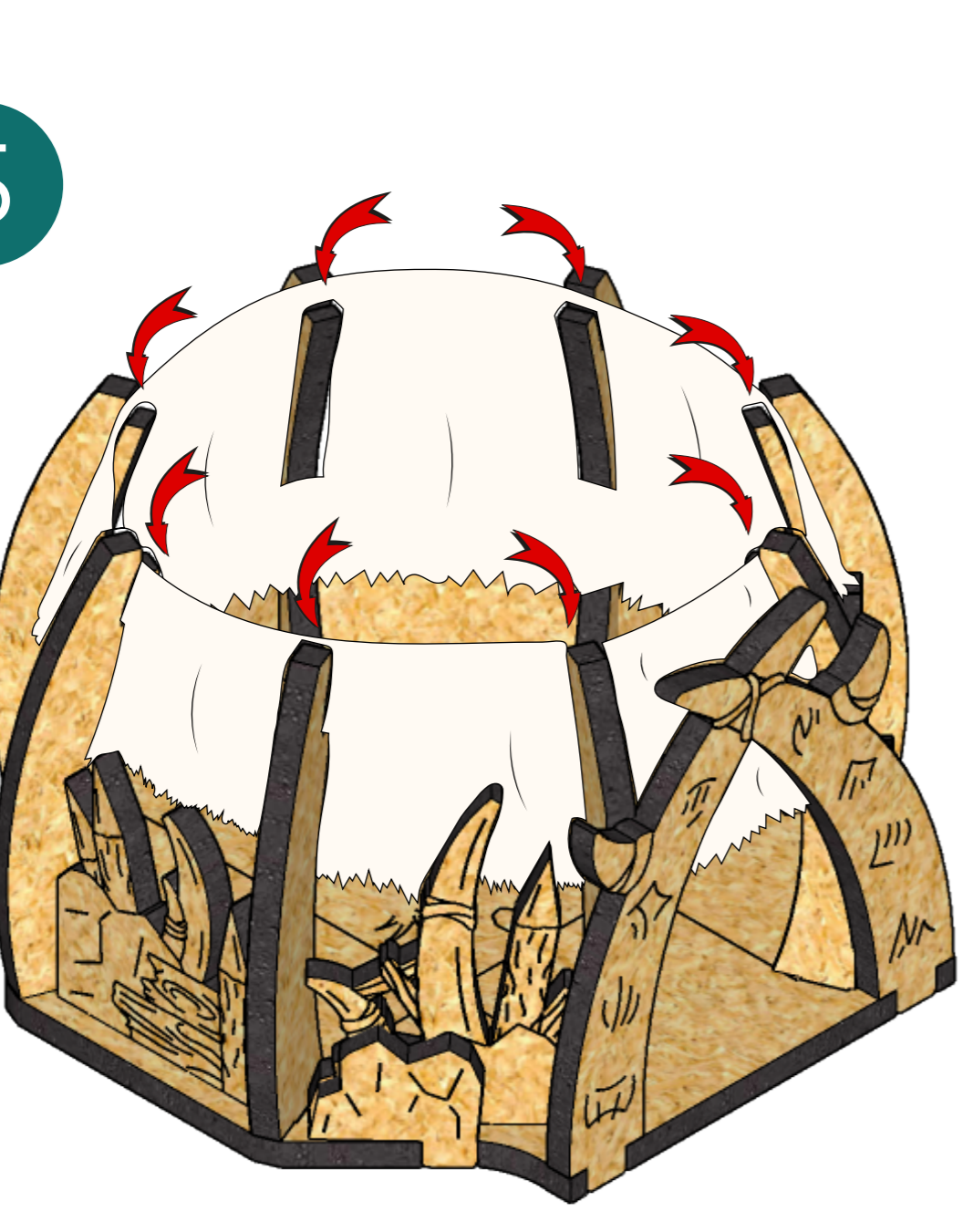

6

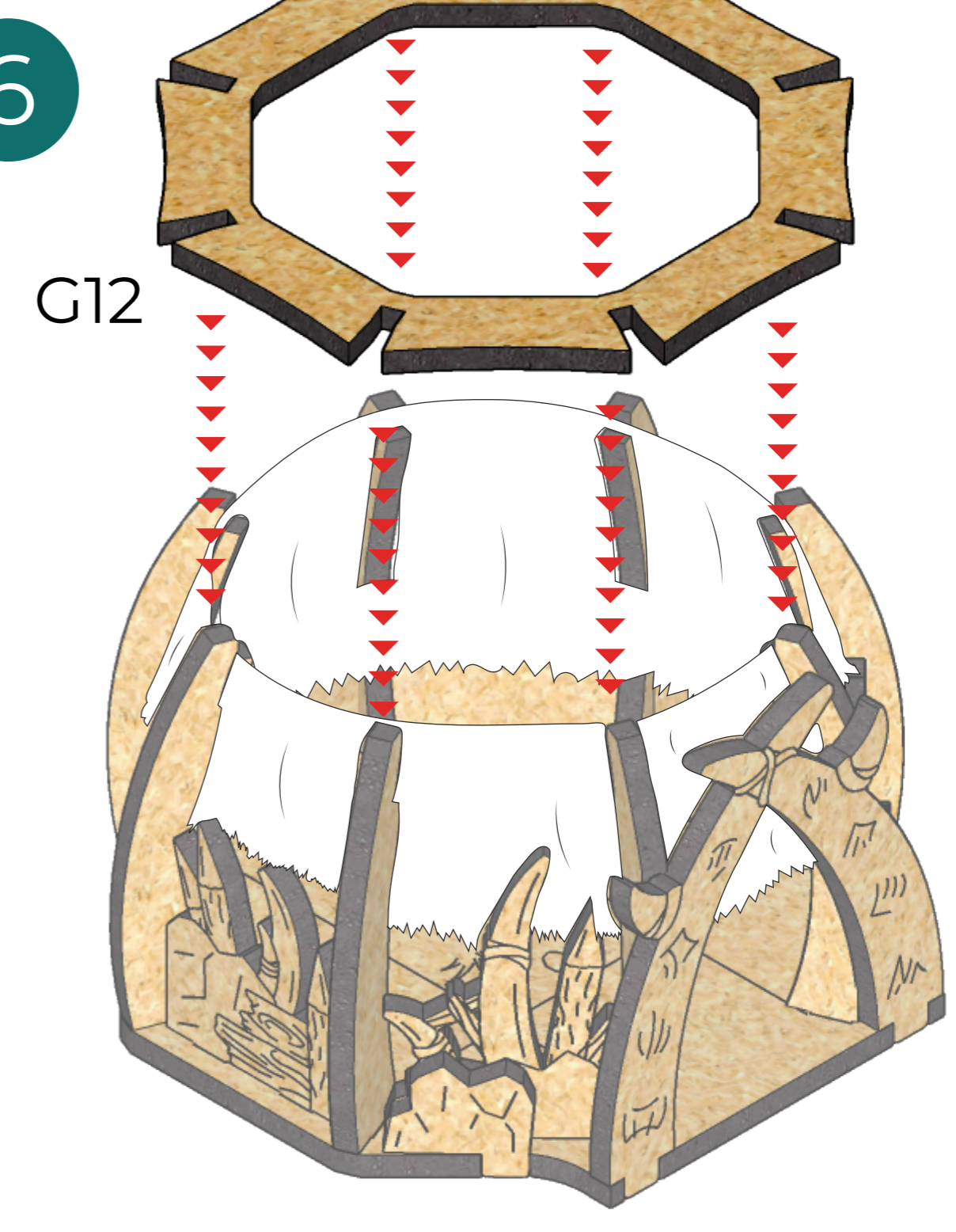

7

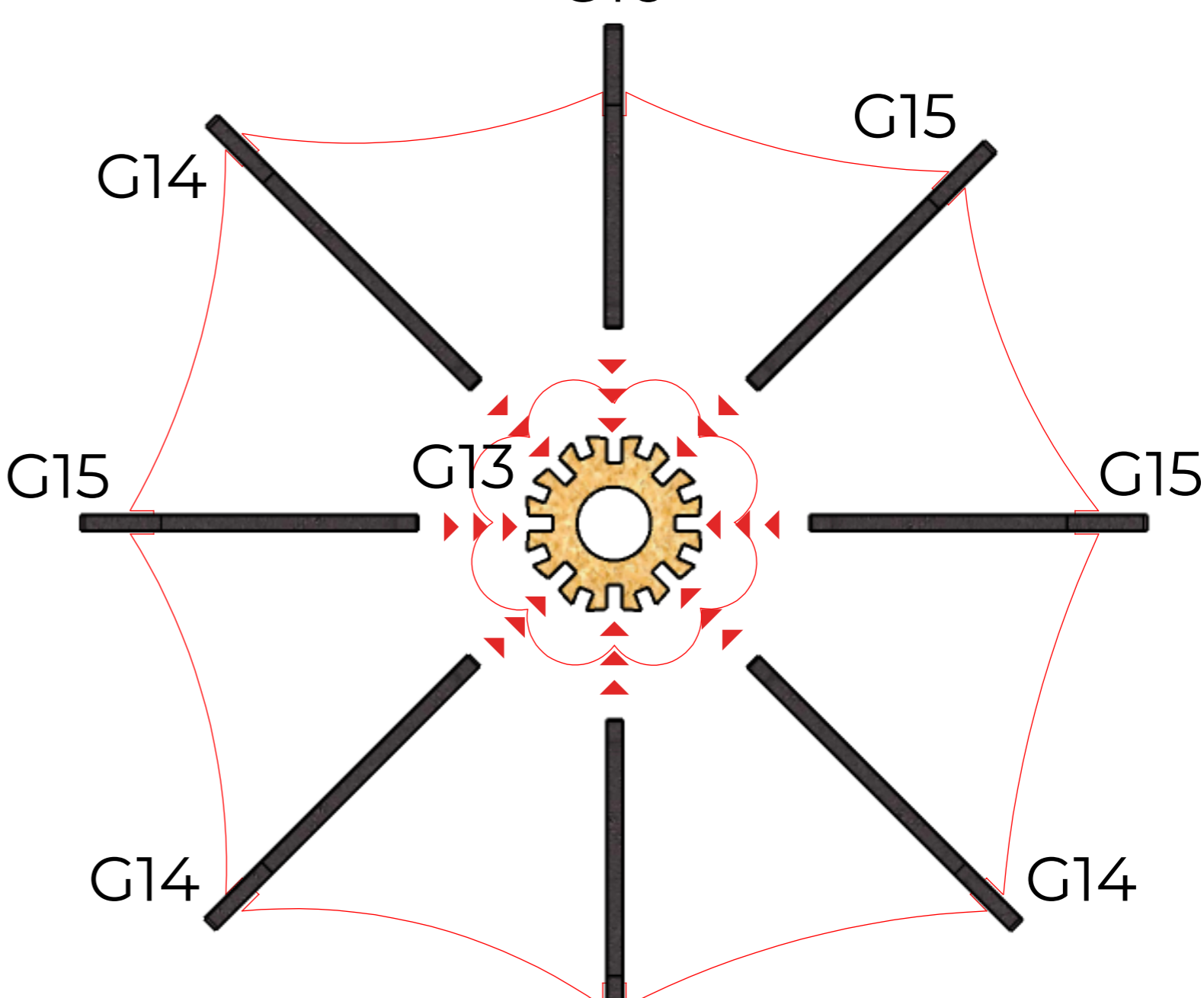
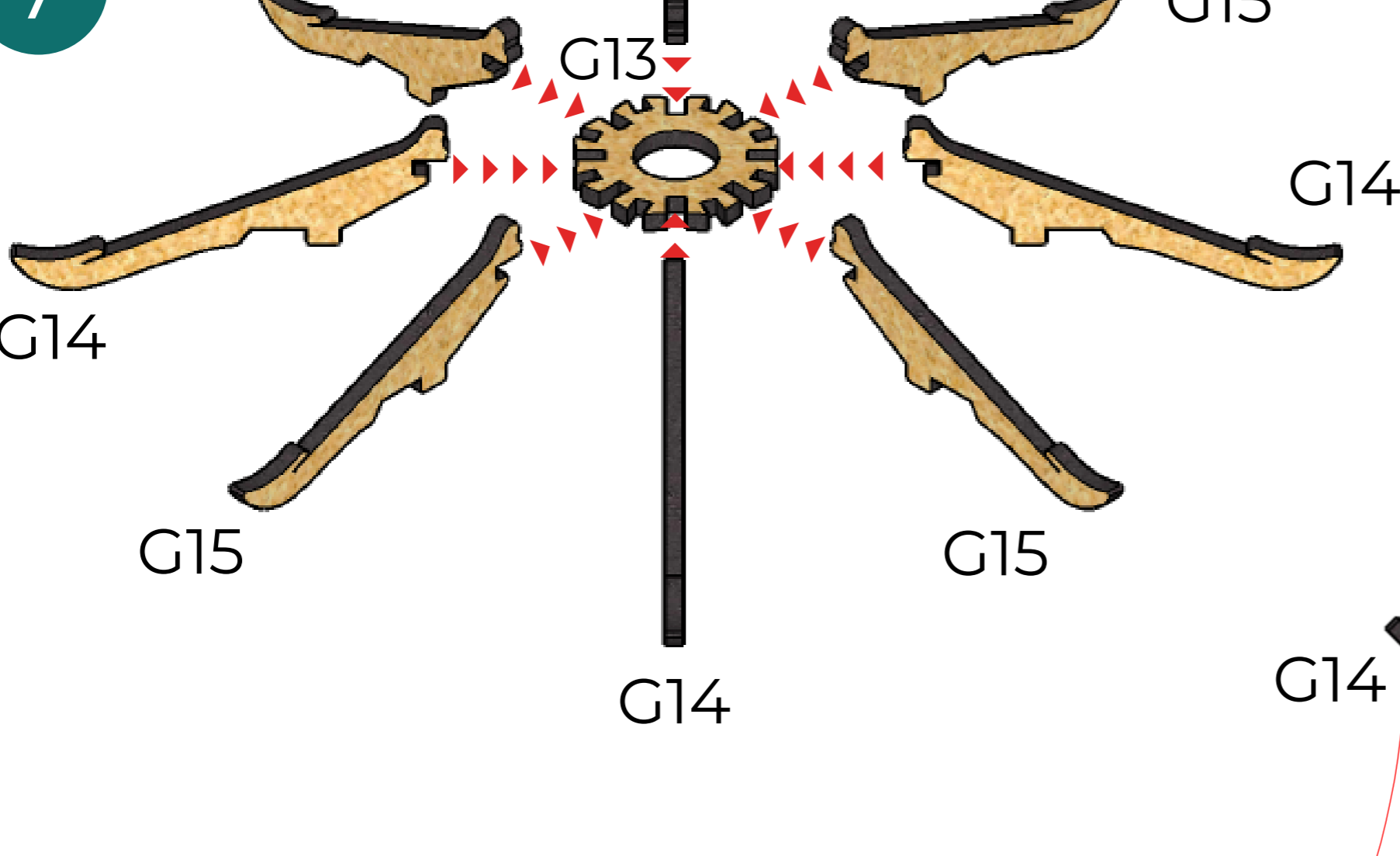

Details G14-G16 should be positioned exactly as it is shown on the instruction to work correctly.
Деталі G14-G16 мають розташовуватись саме так, як показано в інструкції.

8

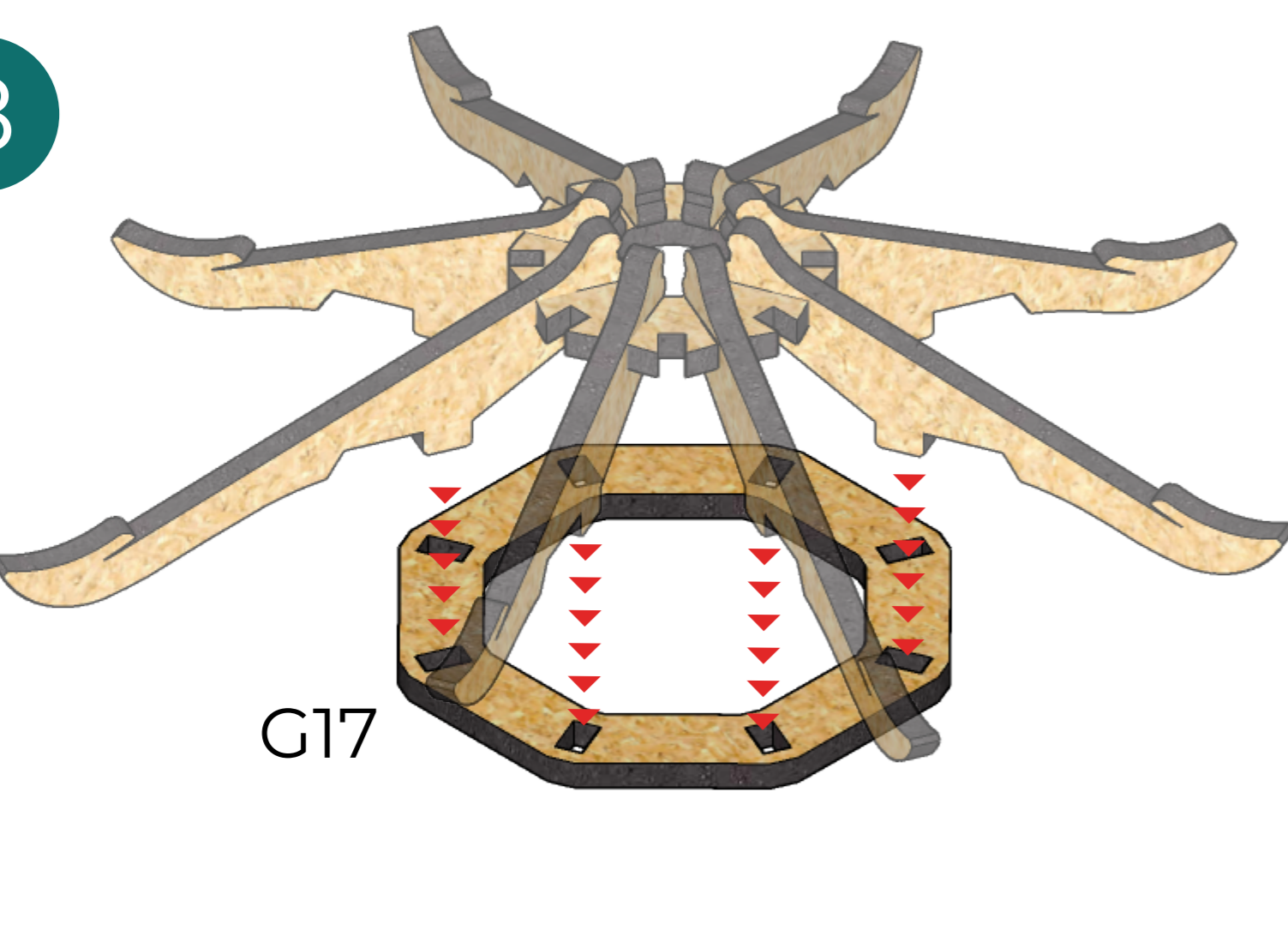

9

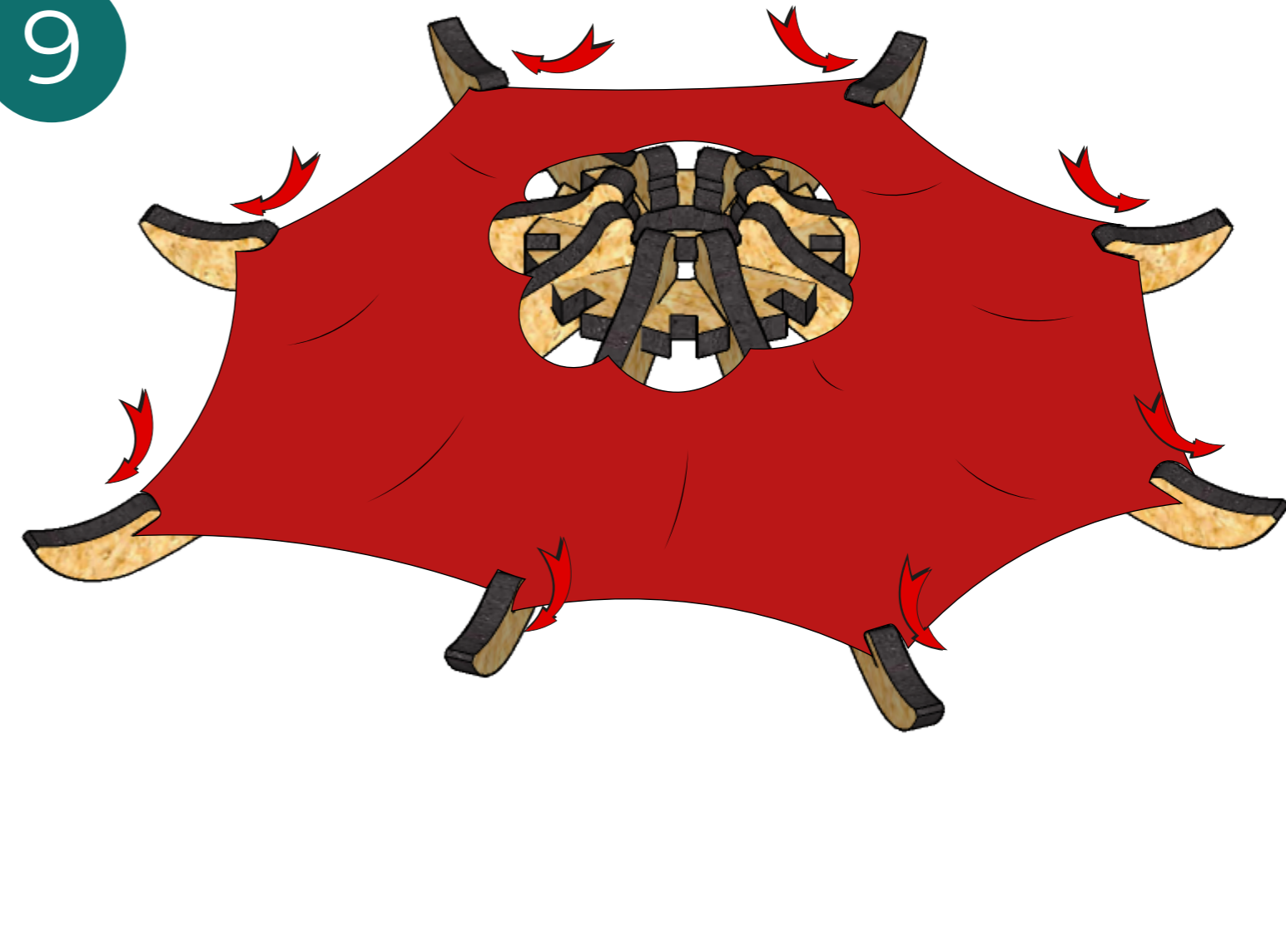

10

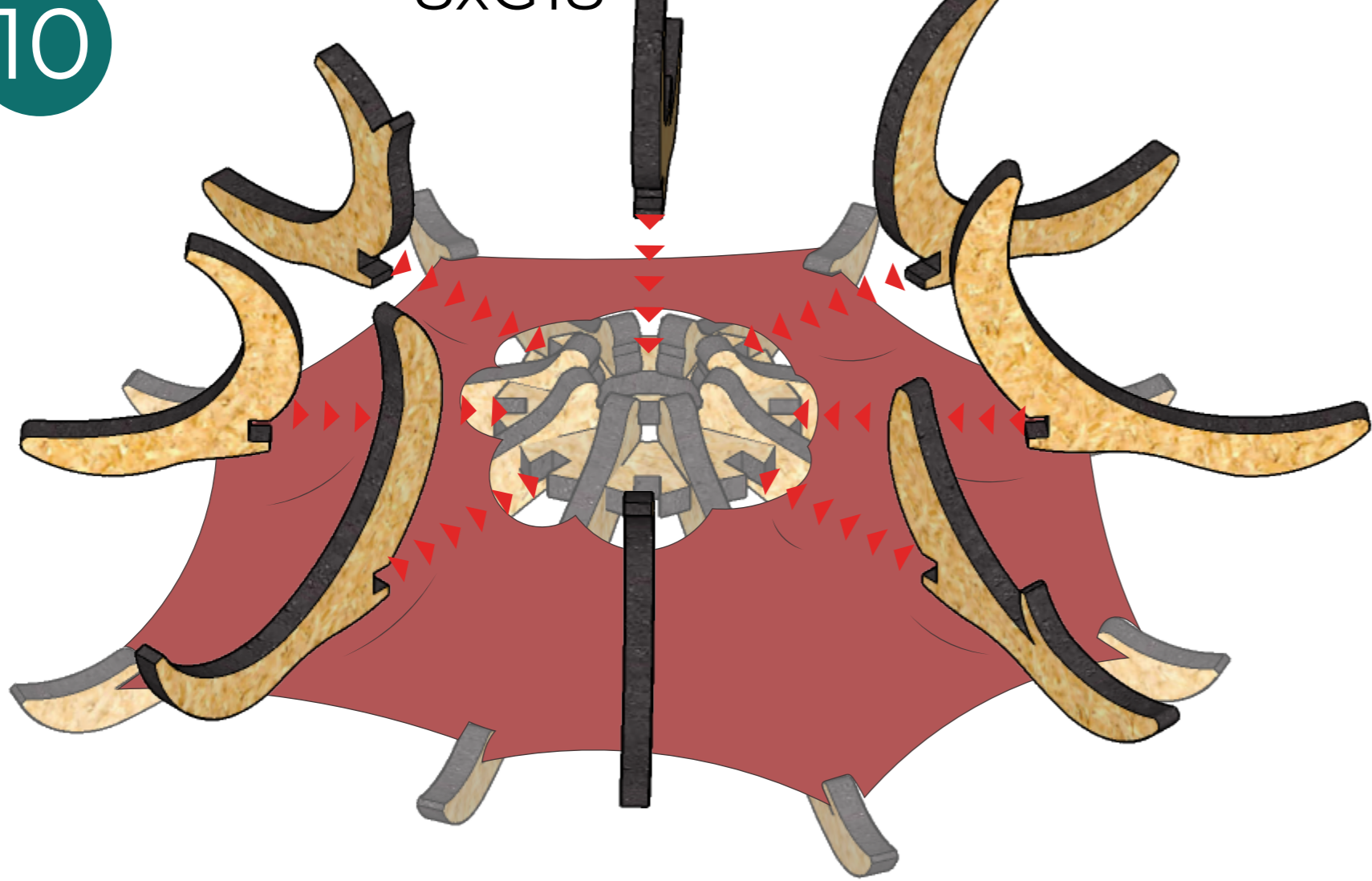

The G18 details are interchangeable and can be positioned in any configuration.
Деталі G18 взаємозамінні і можуть розташовуватись в будь-якій послідовності.

11

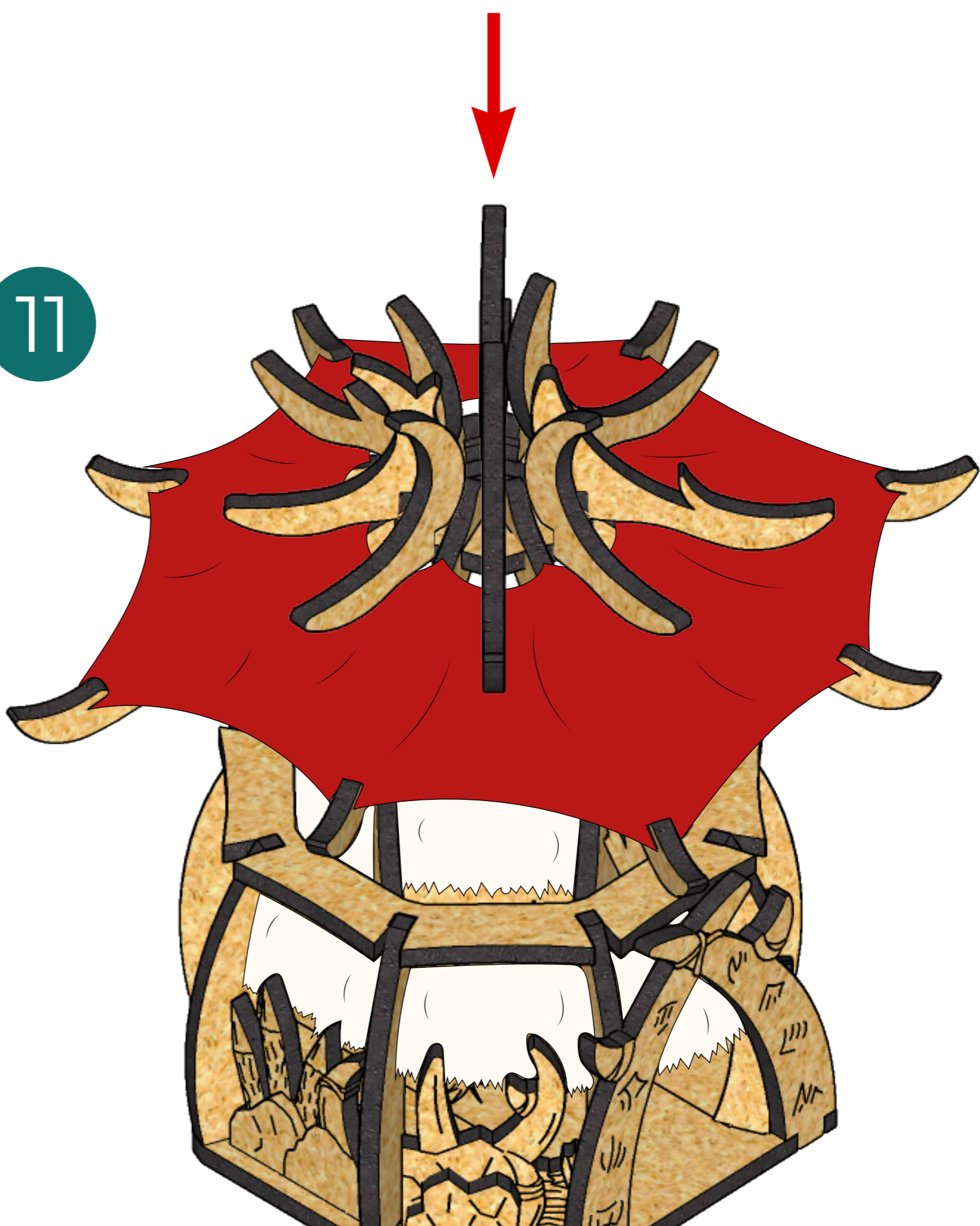

H

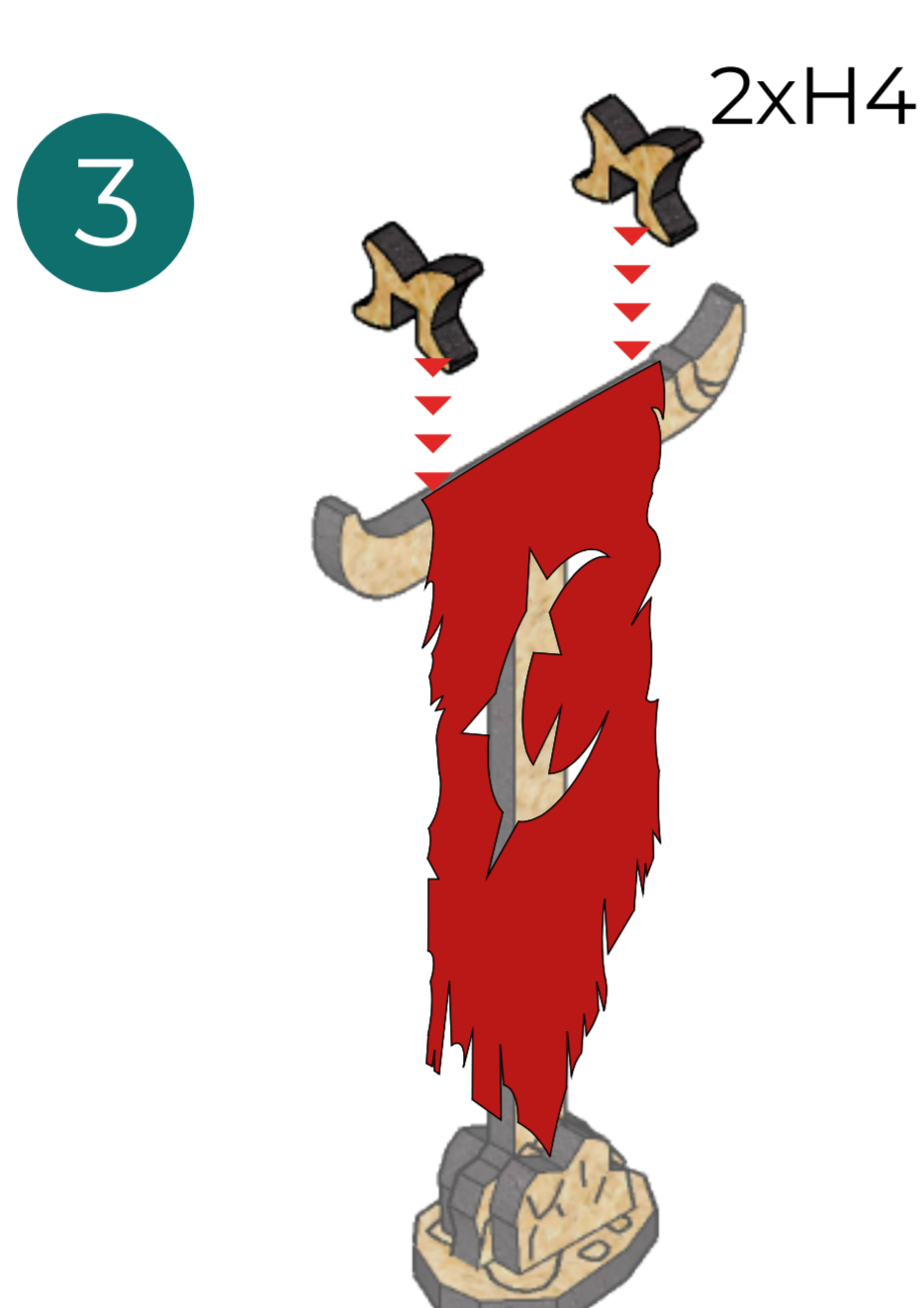
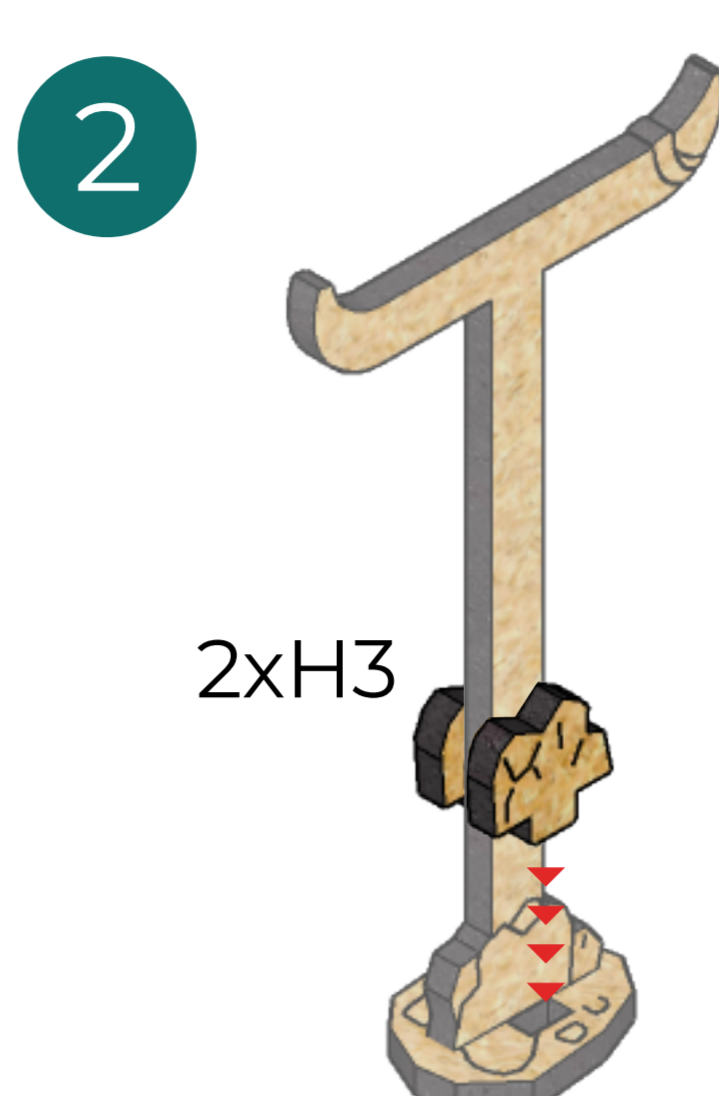
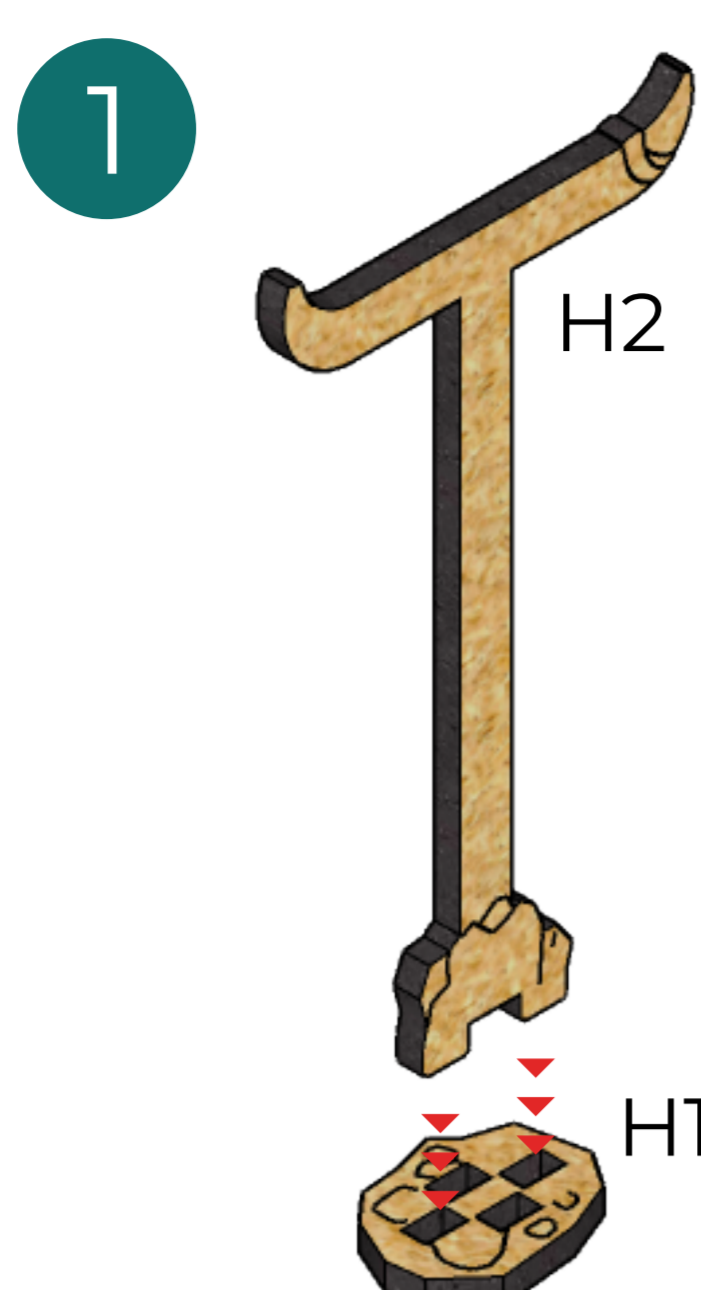

I

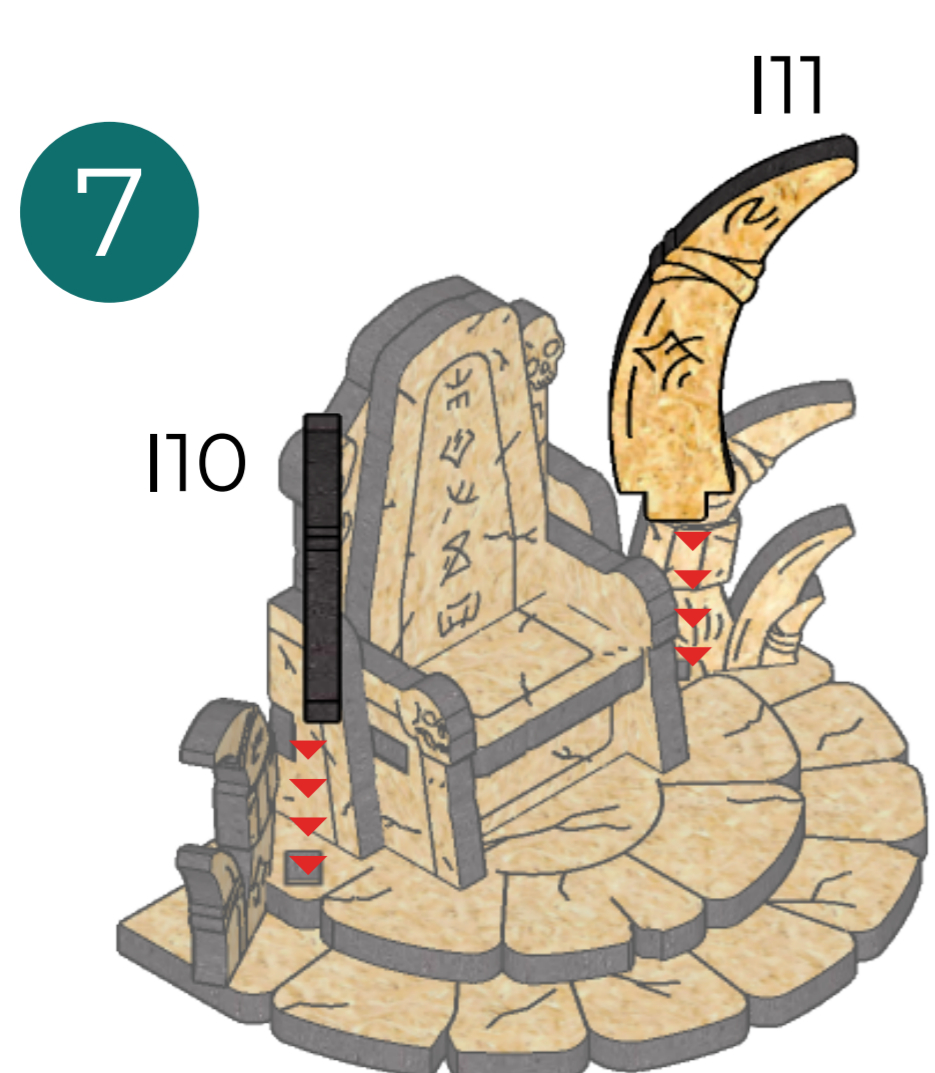
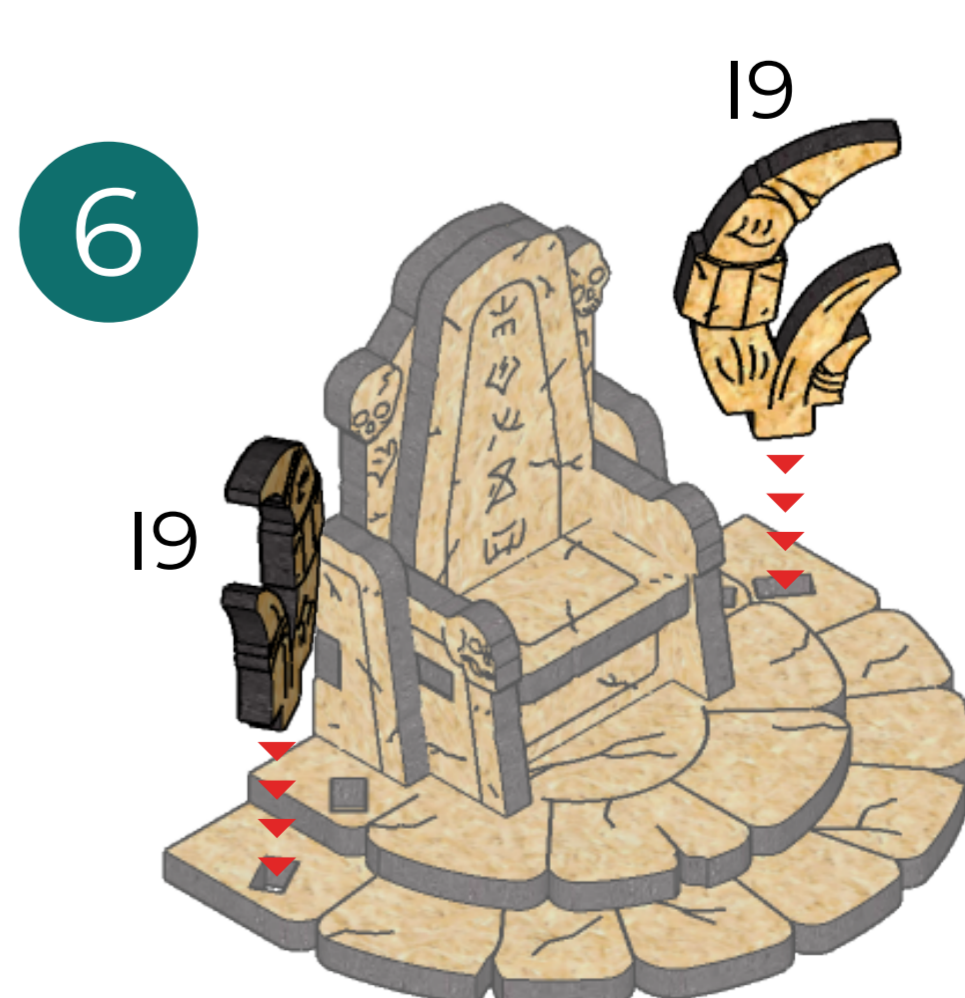
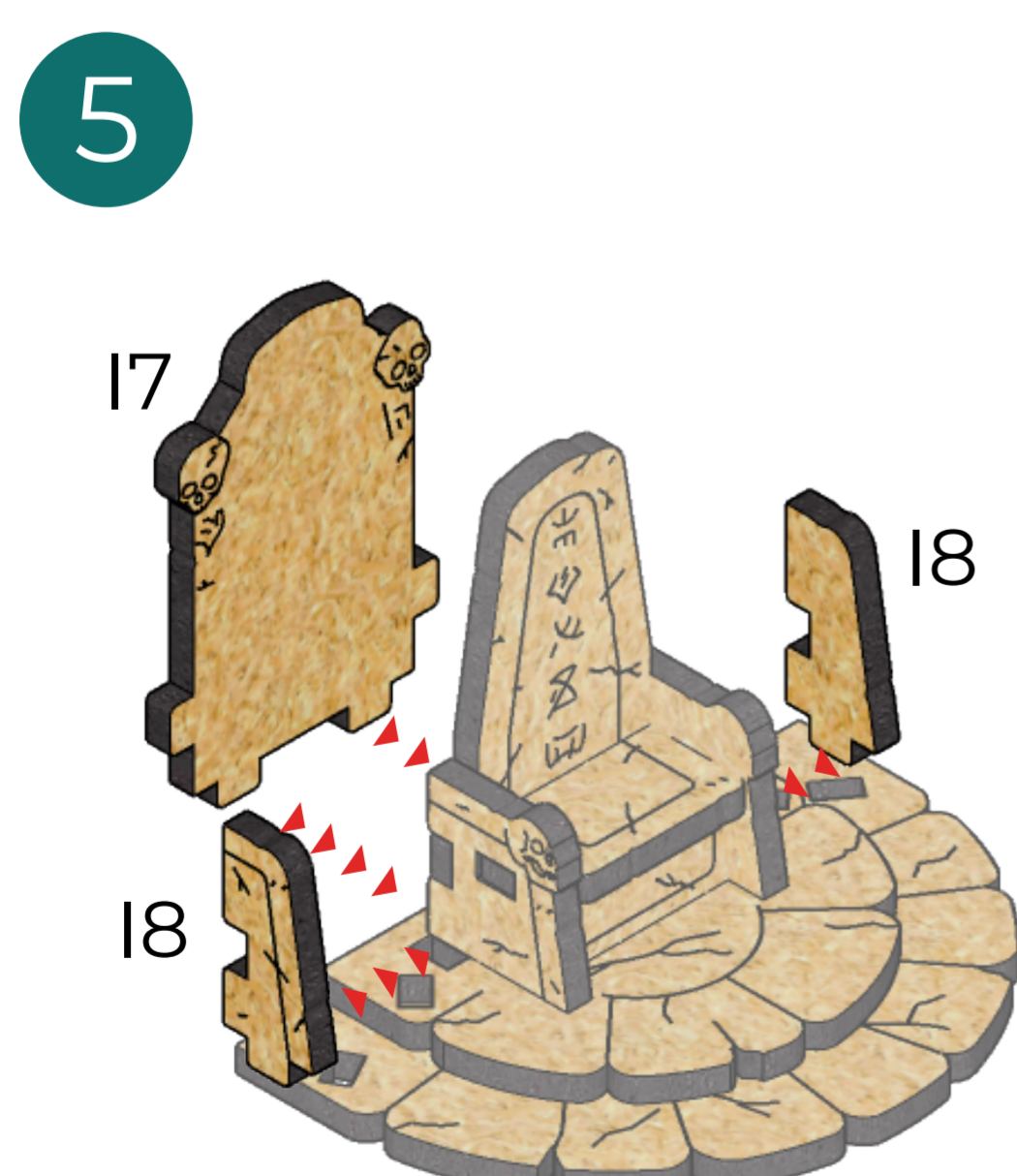
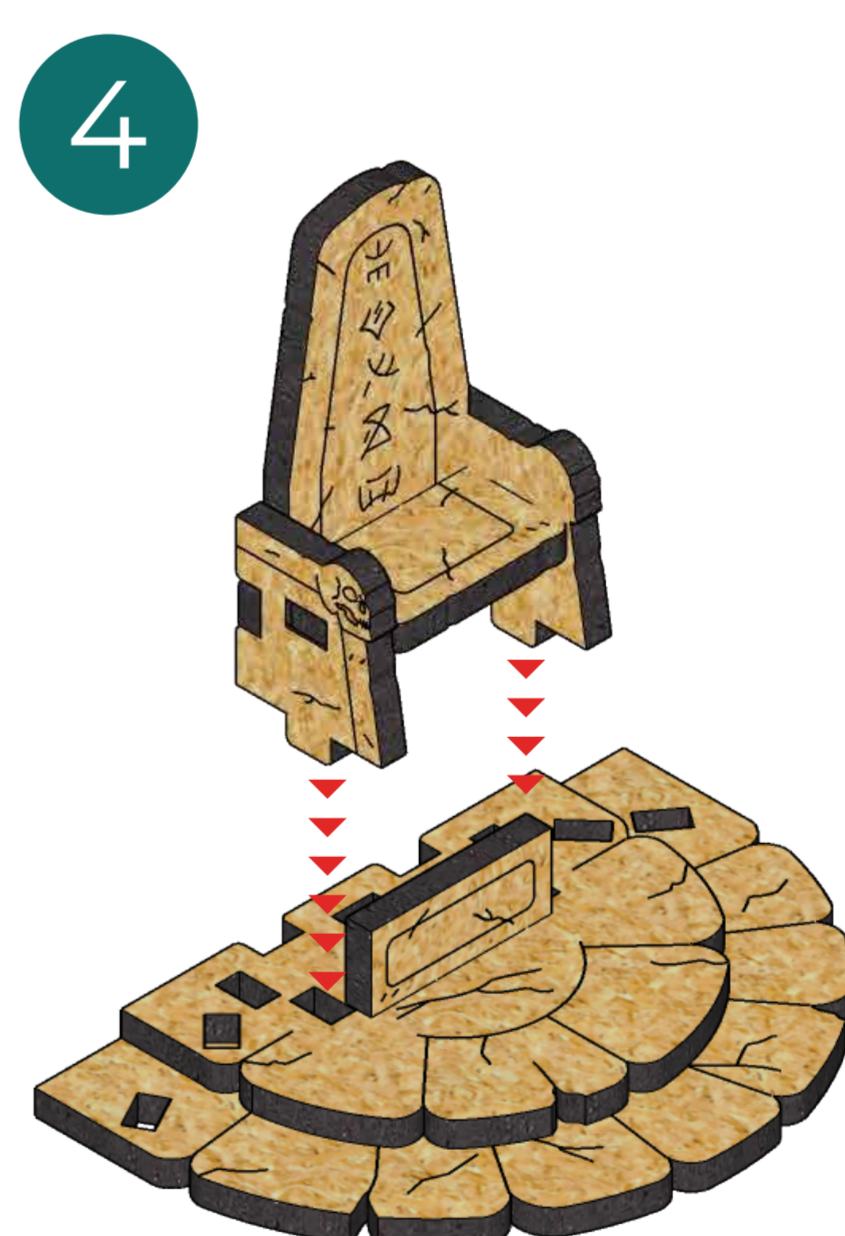
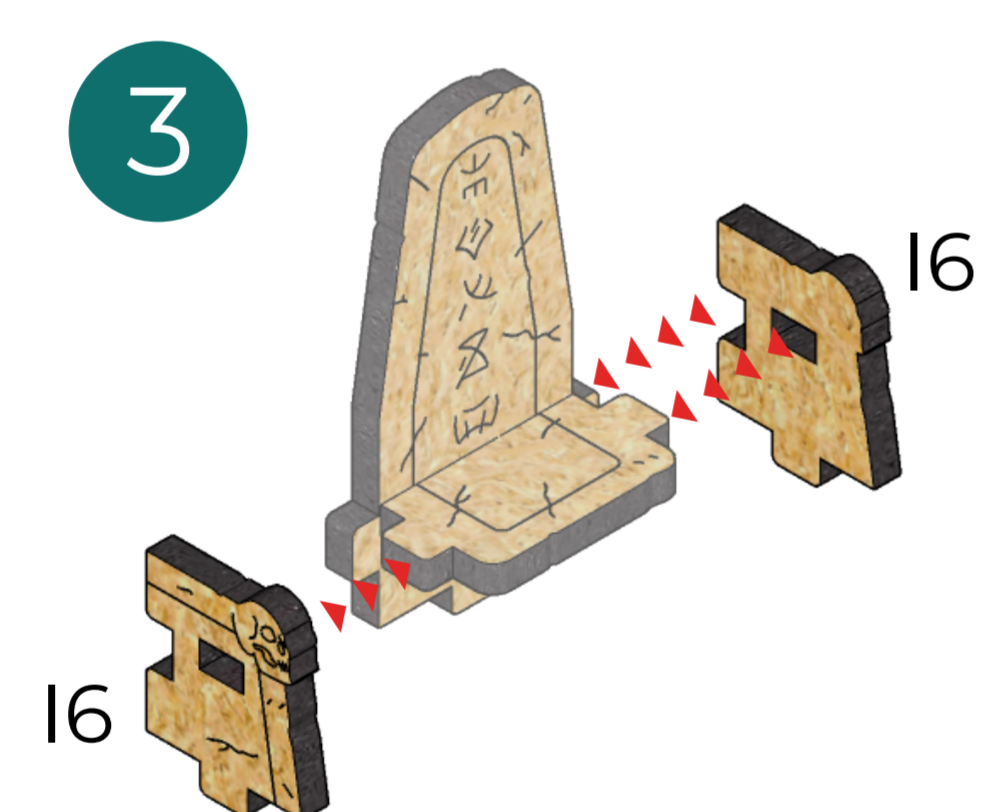
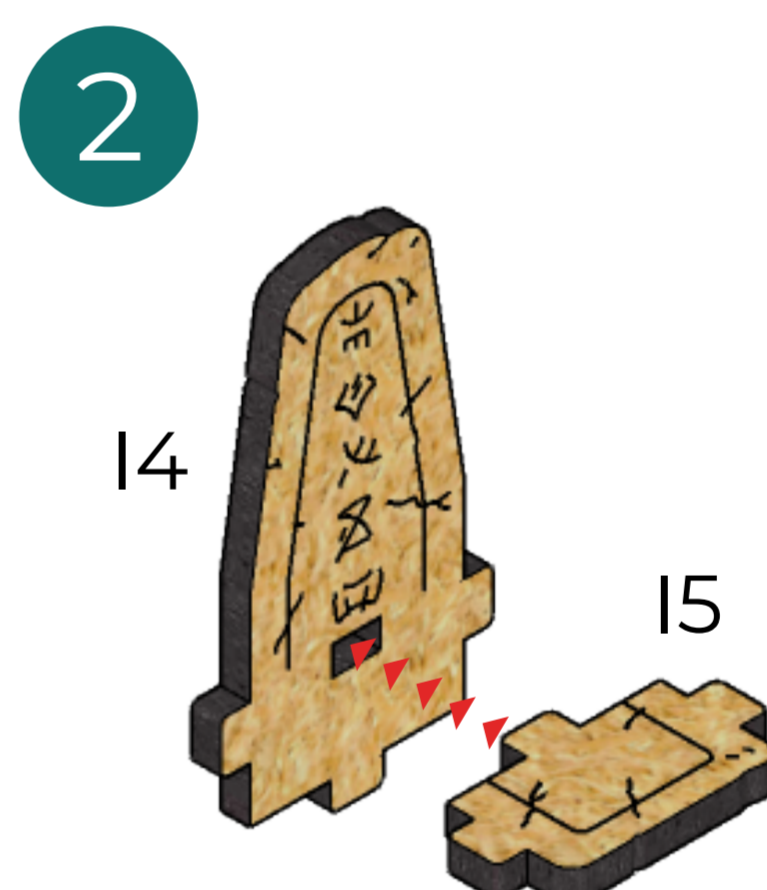
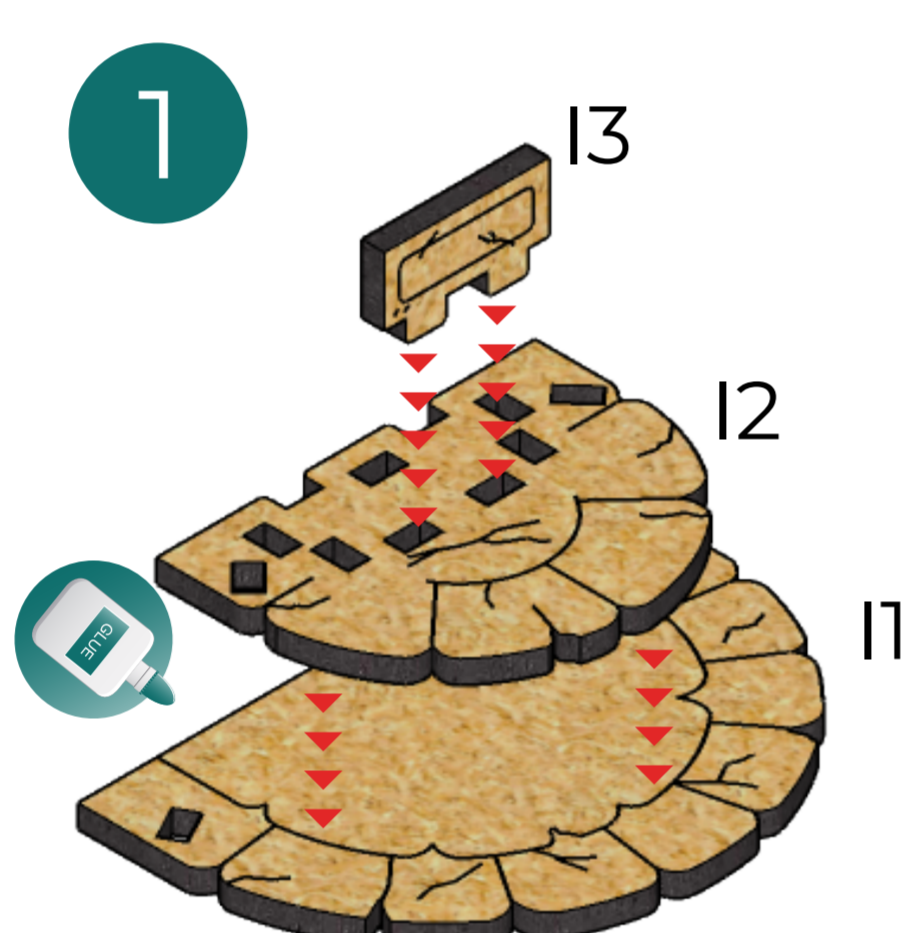

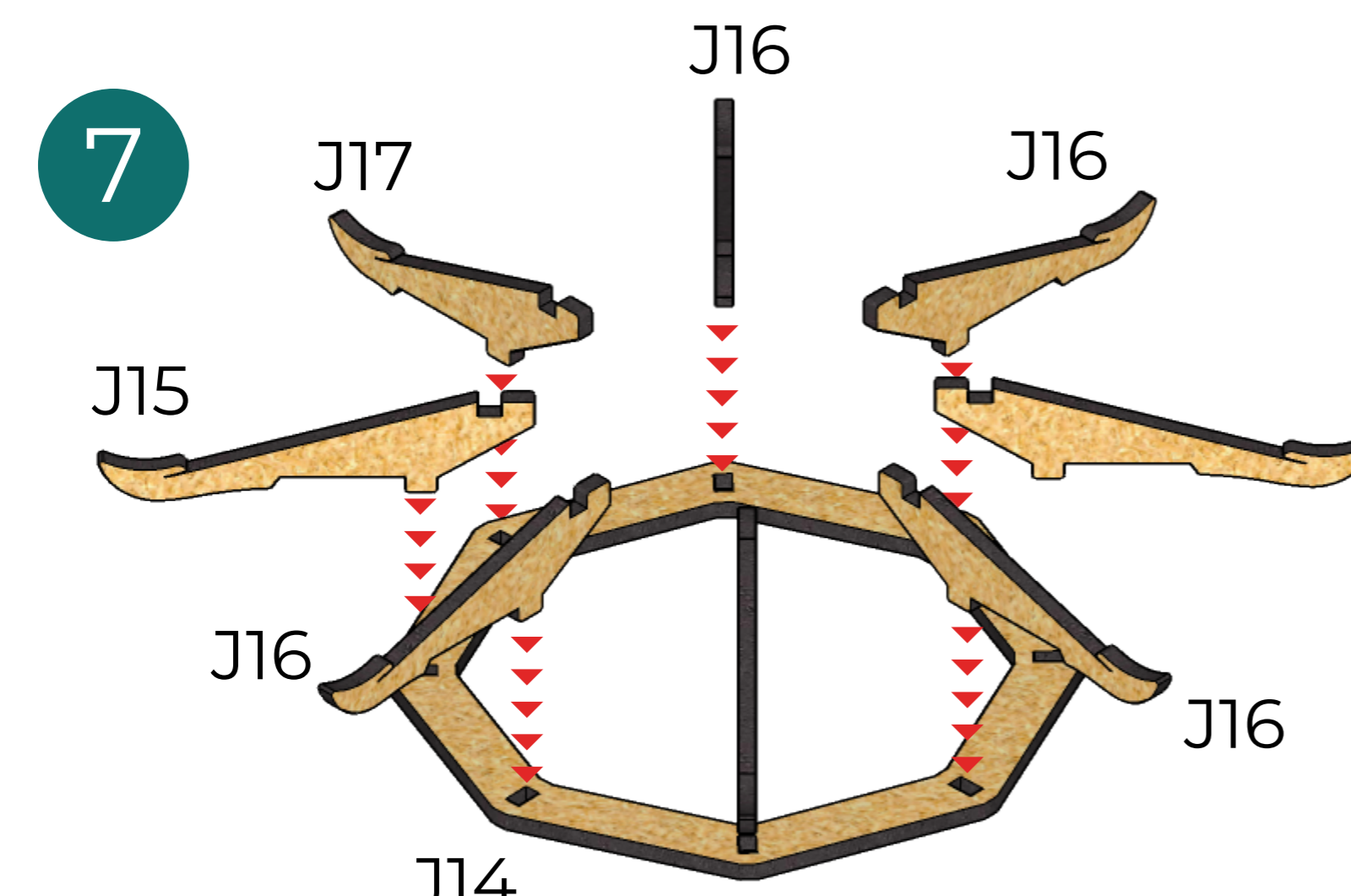
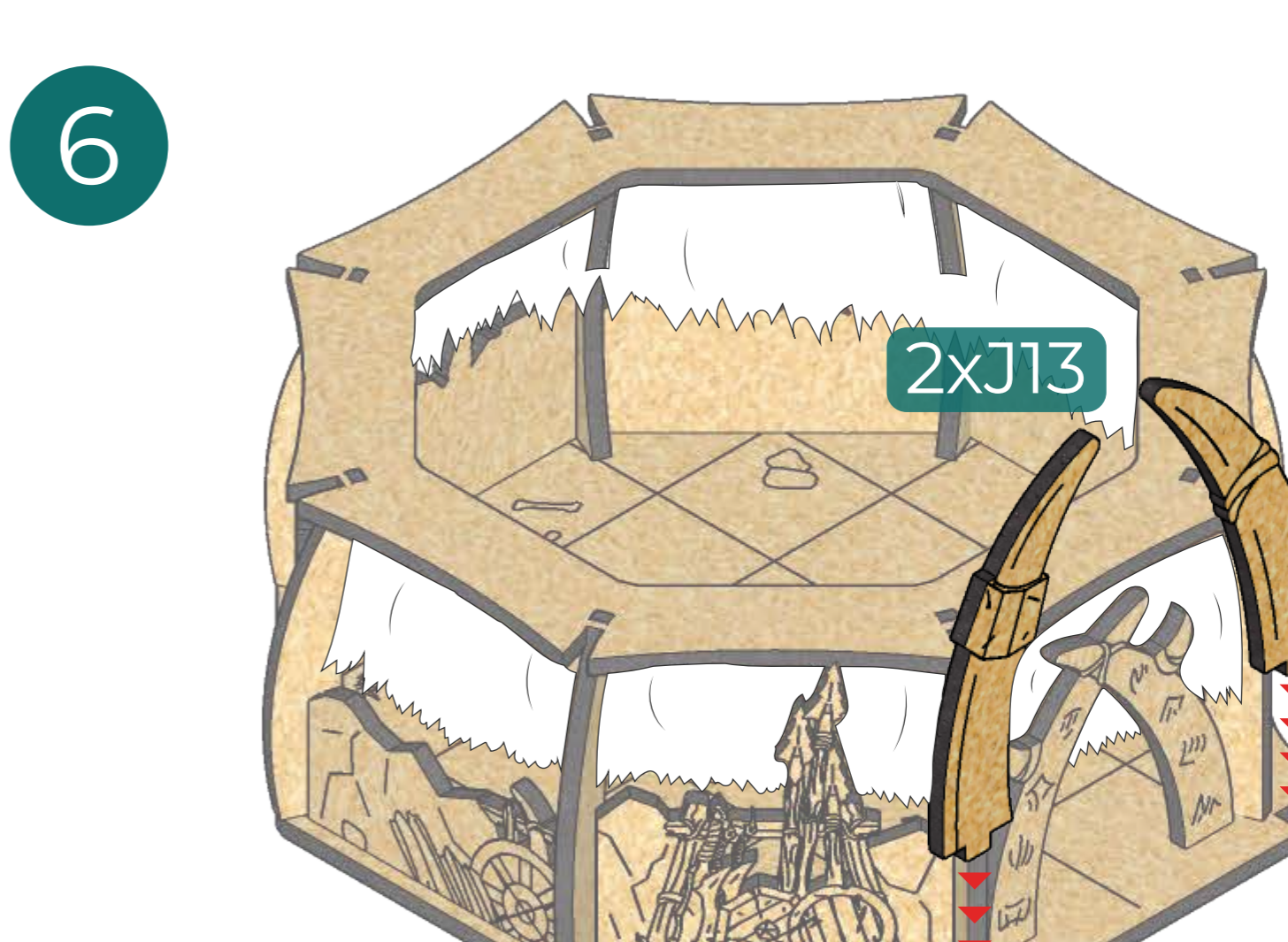
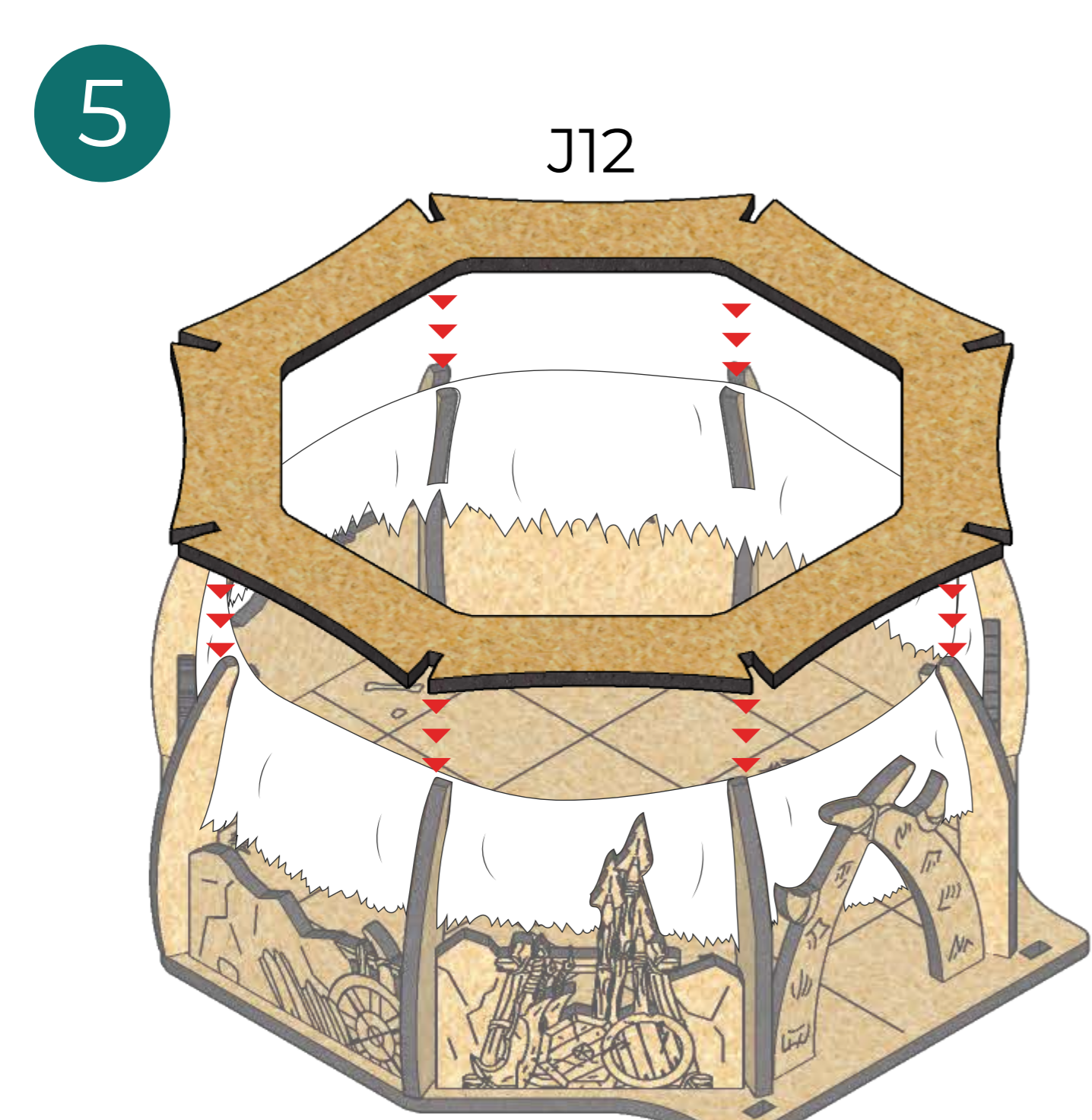
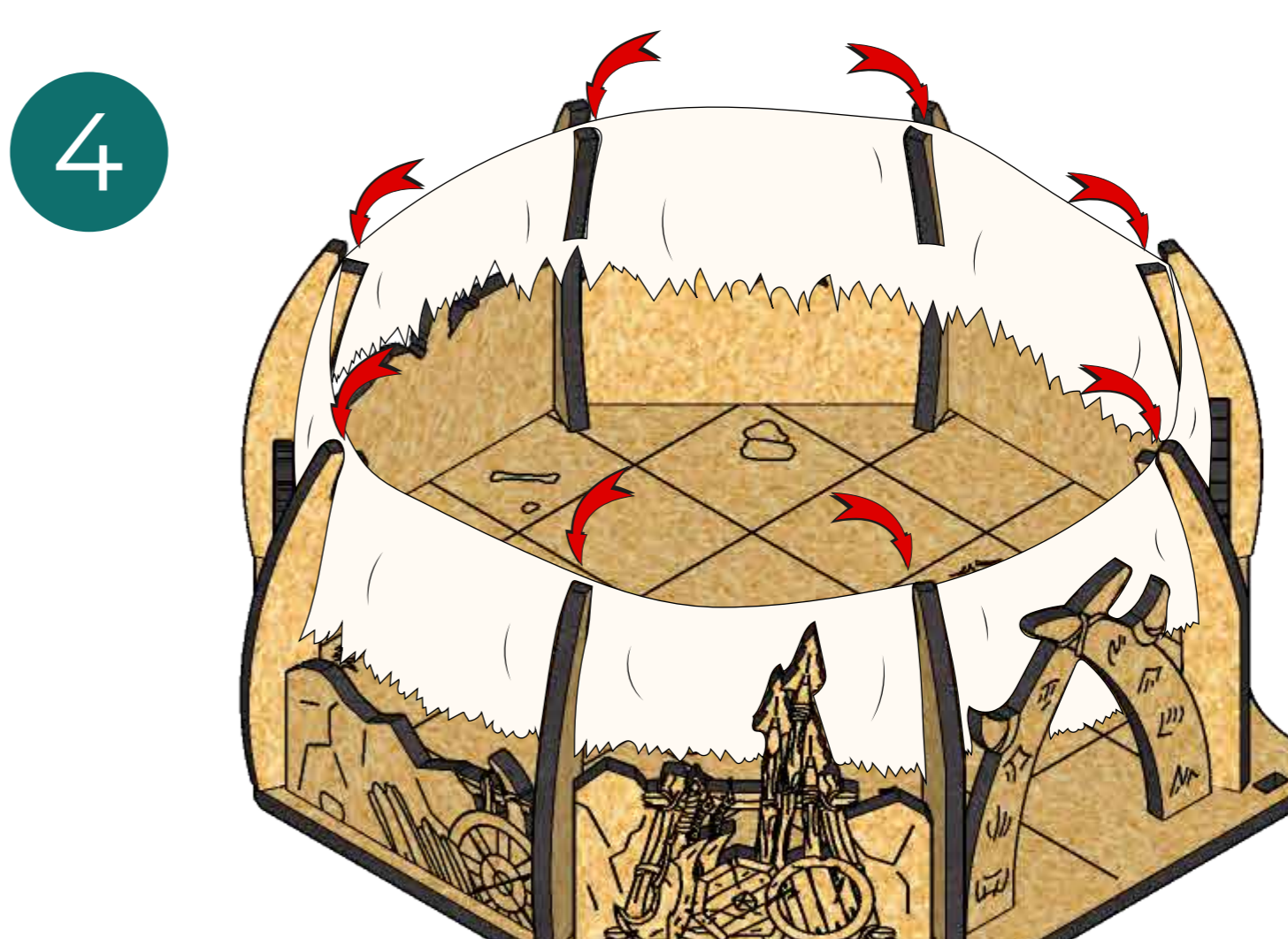
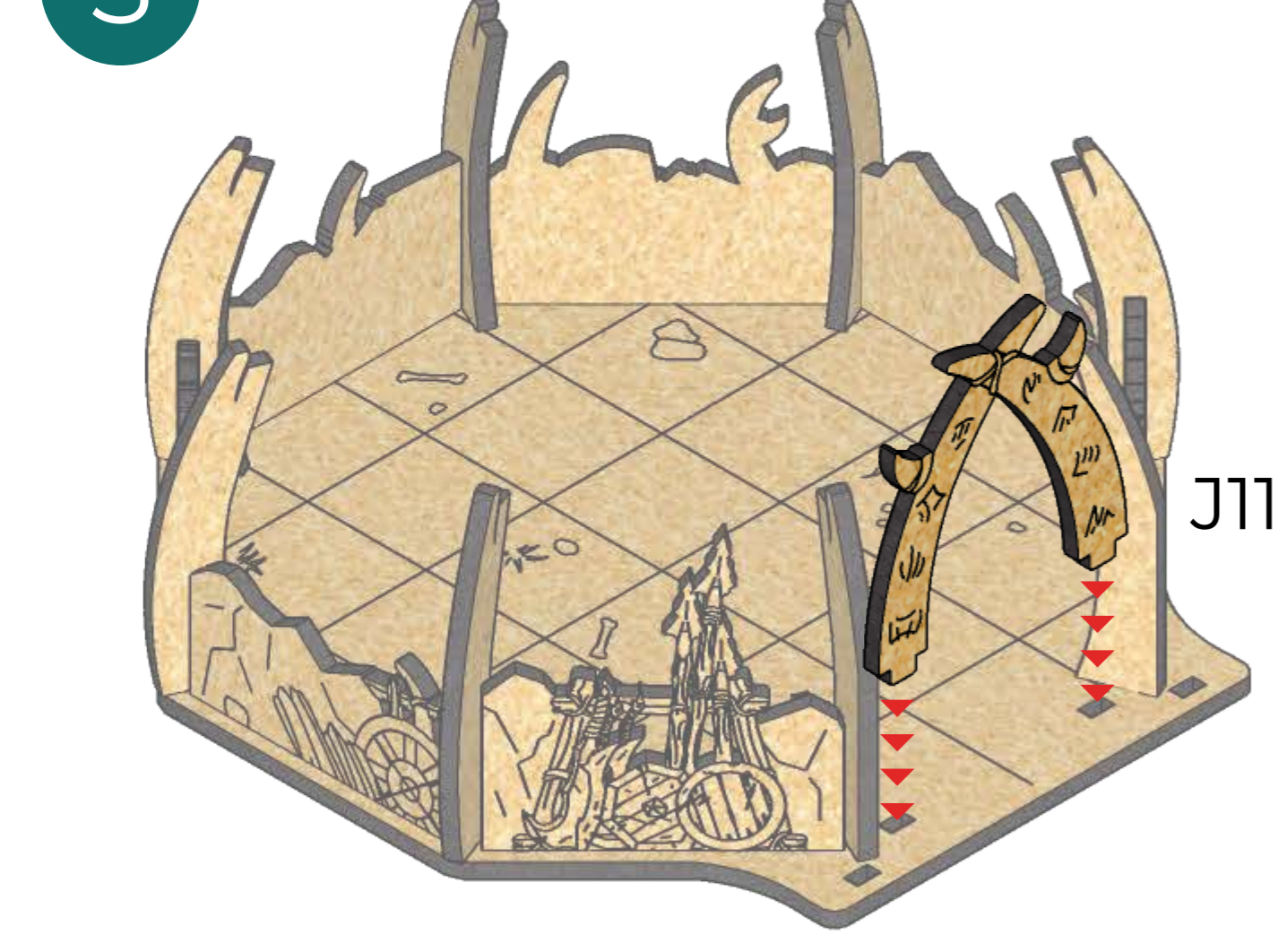
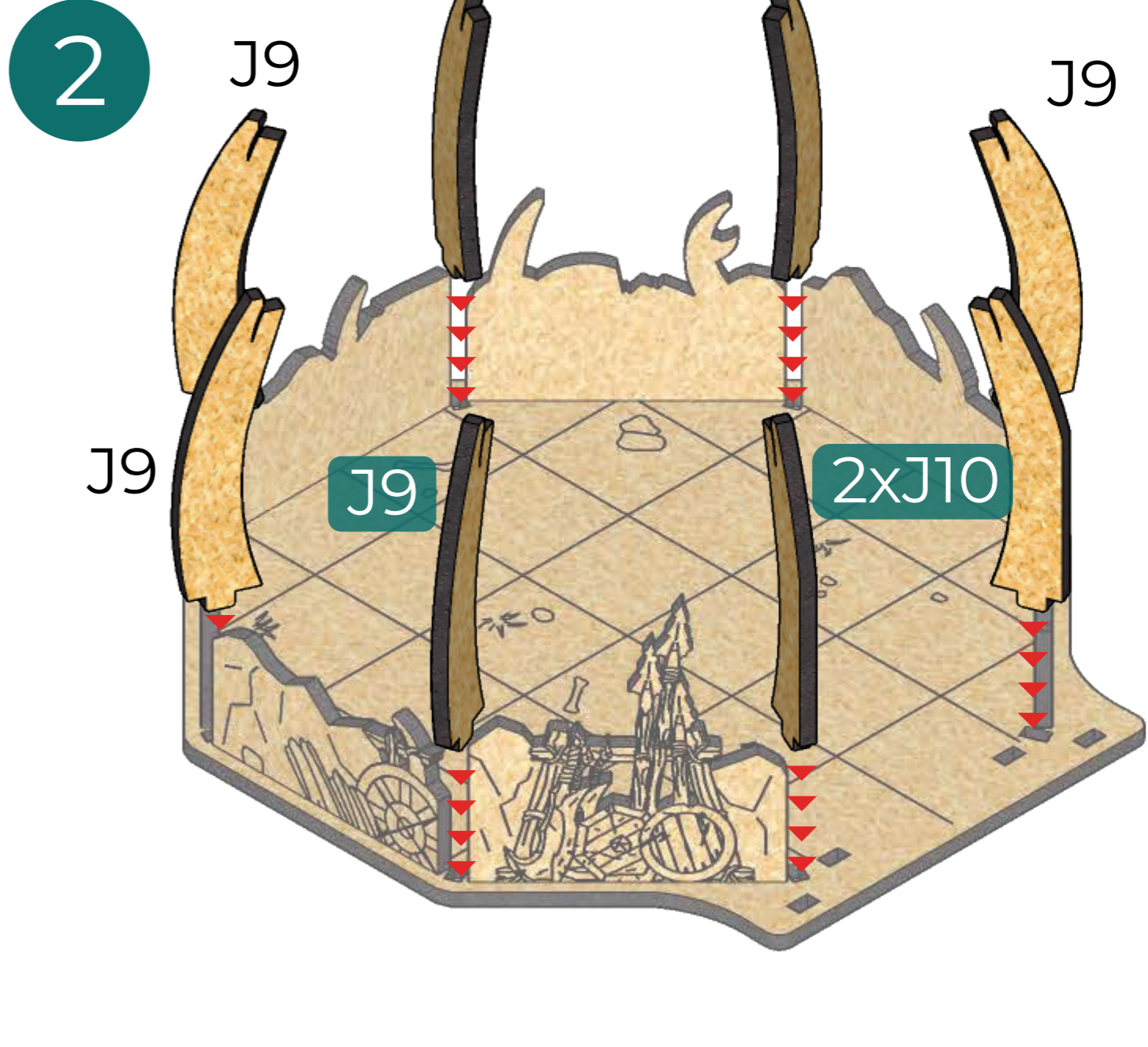
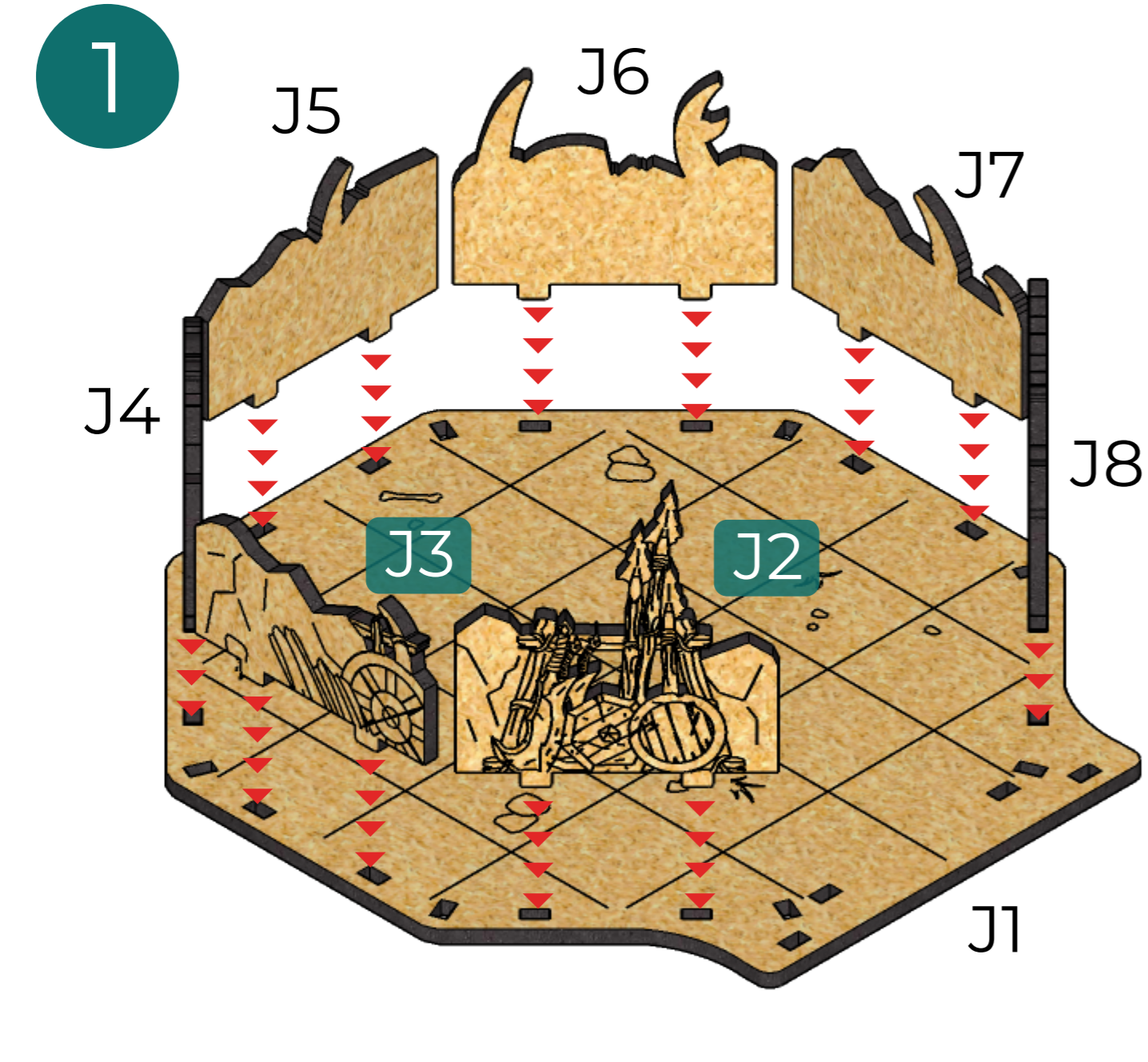

Details J15-J17 should be positioned exactly as it is shown on the instruction to work correctly.
Деталі J15-J17 мають розташовуватись саме так, як показано в інструкції.

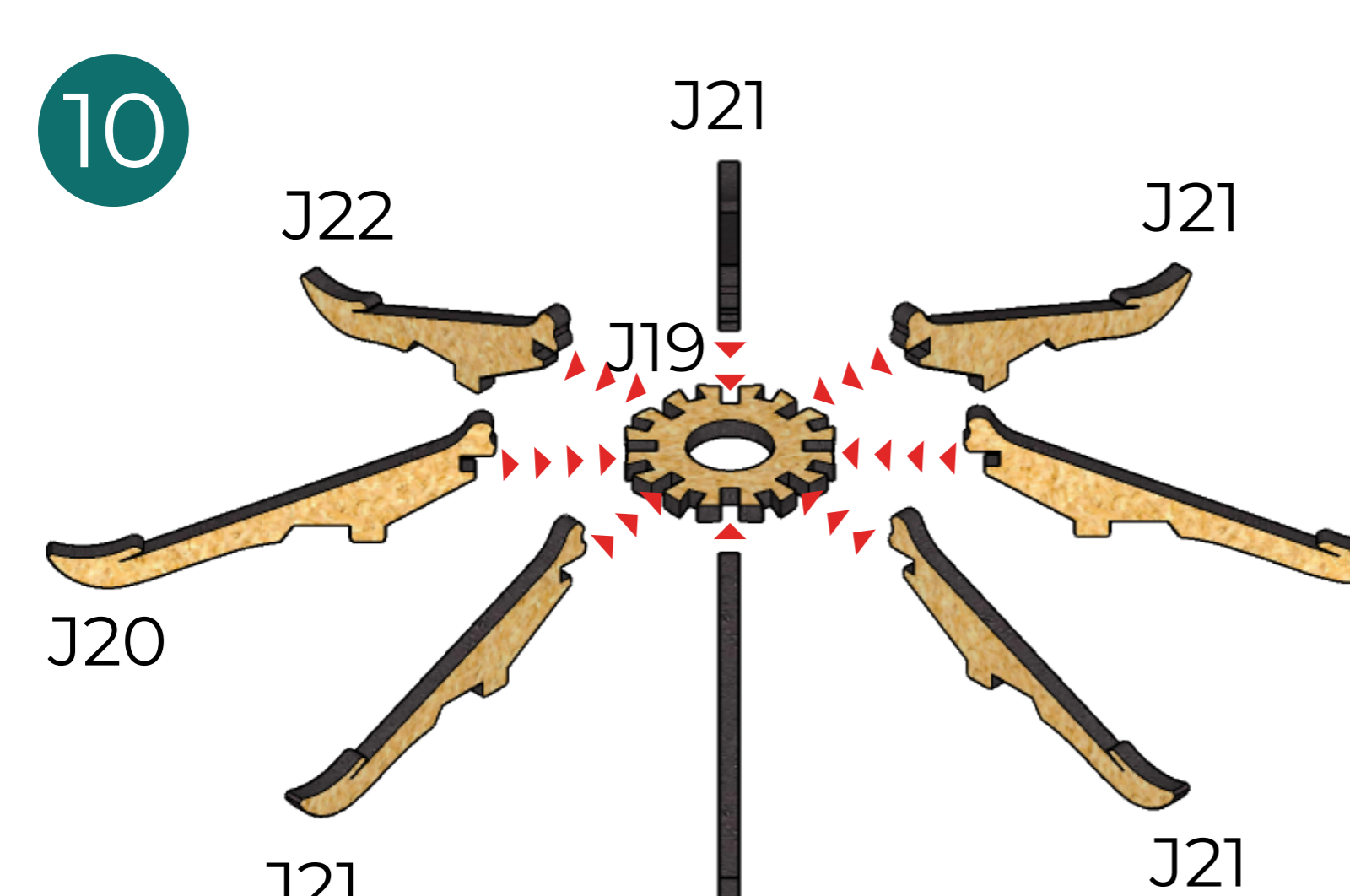
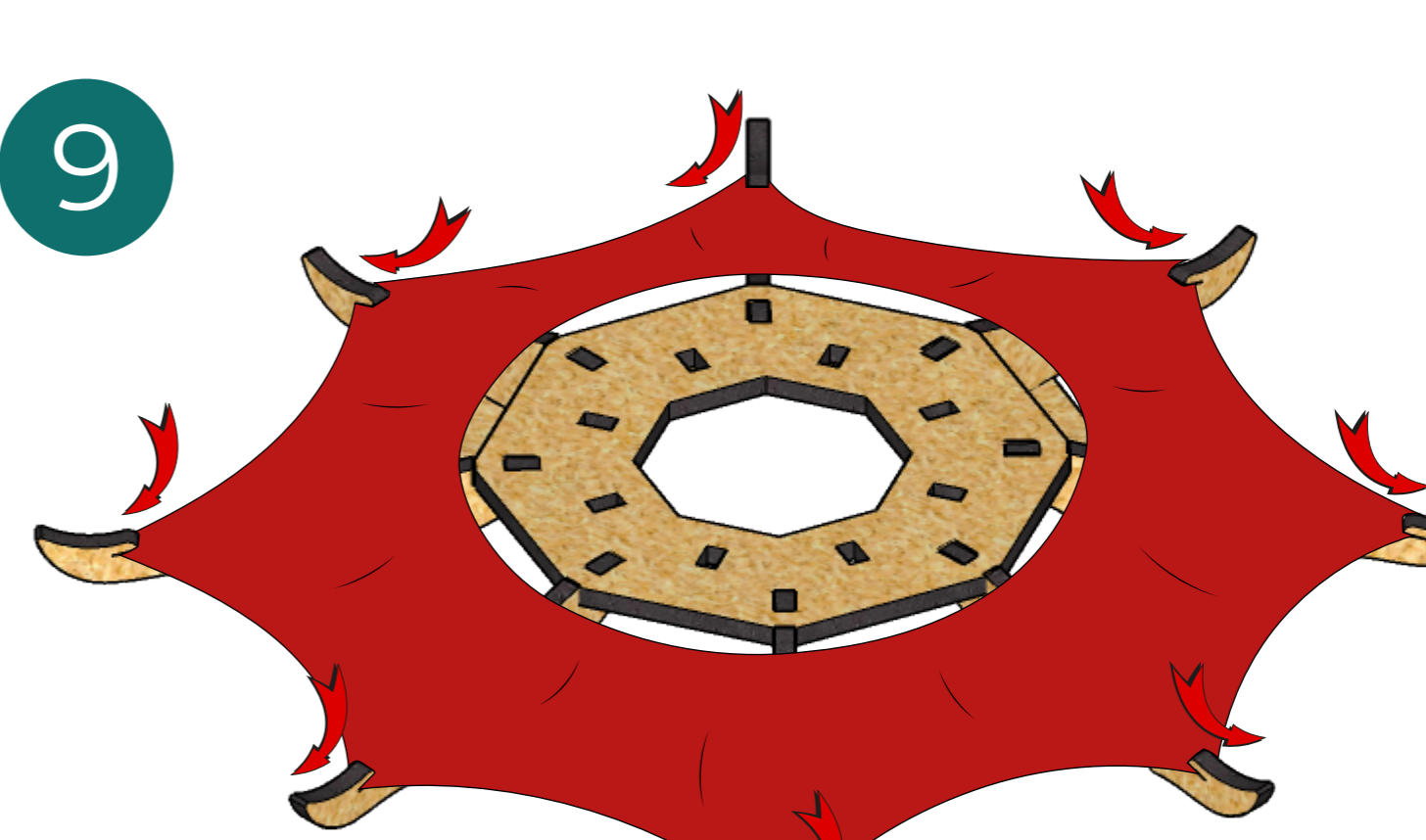
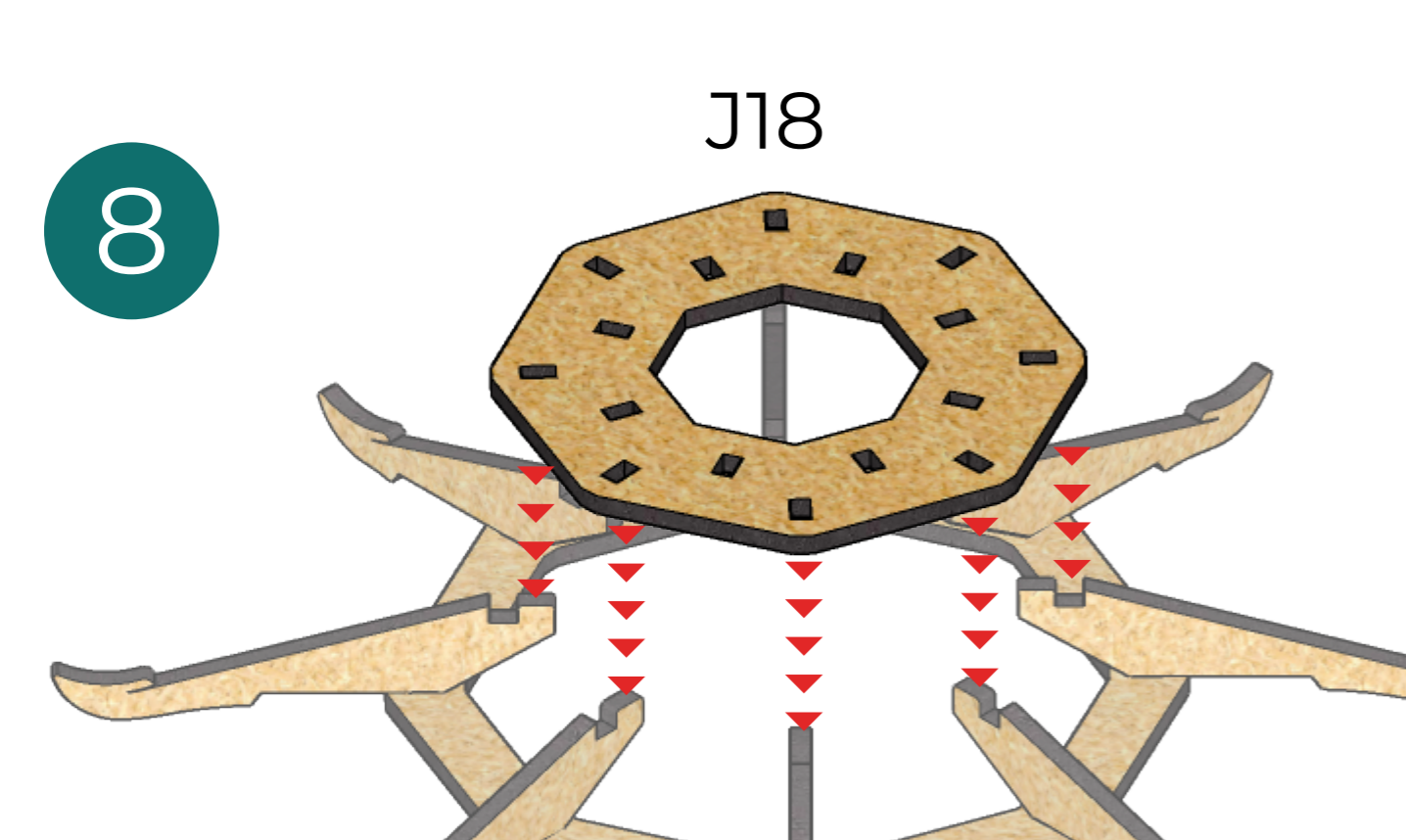
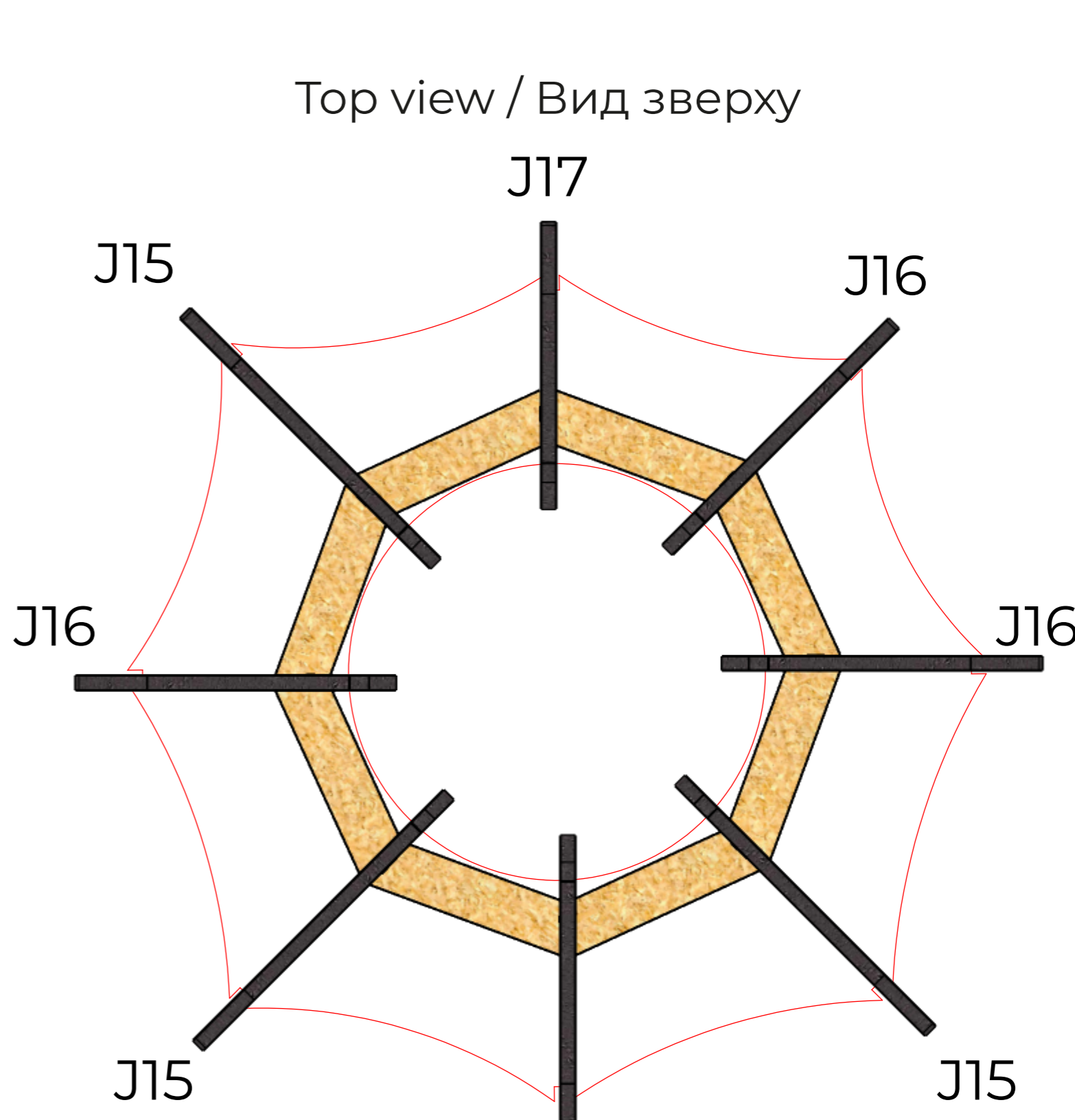

Details J20-J22 should be positioned exactly as it is shown on the instruction to work correctly.
Деталі J20-J22 мають розташовуватись саме так, як показано в інструкції.

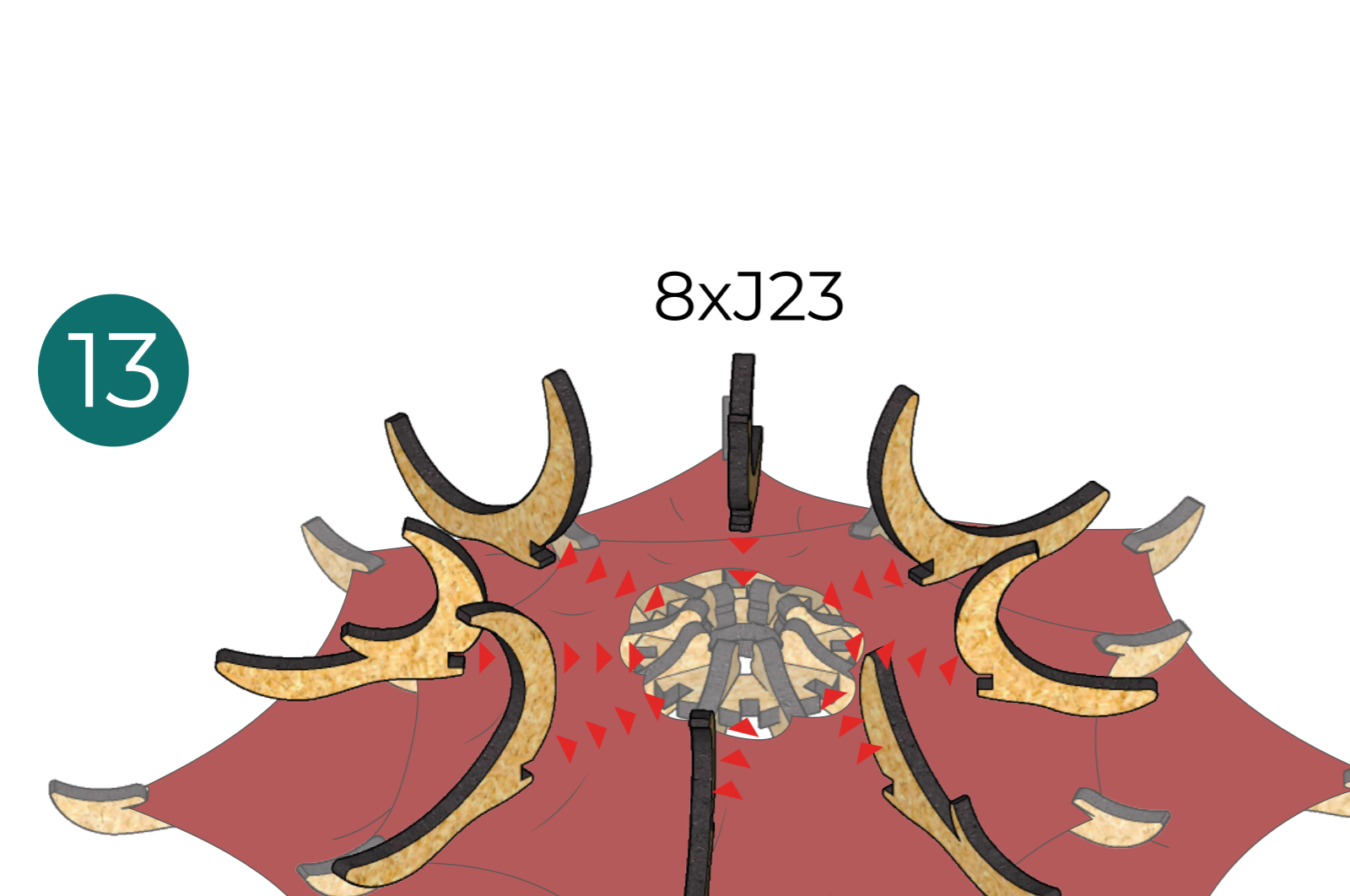
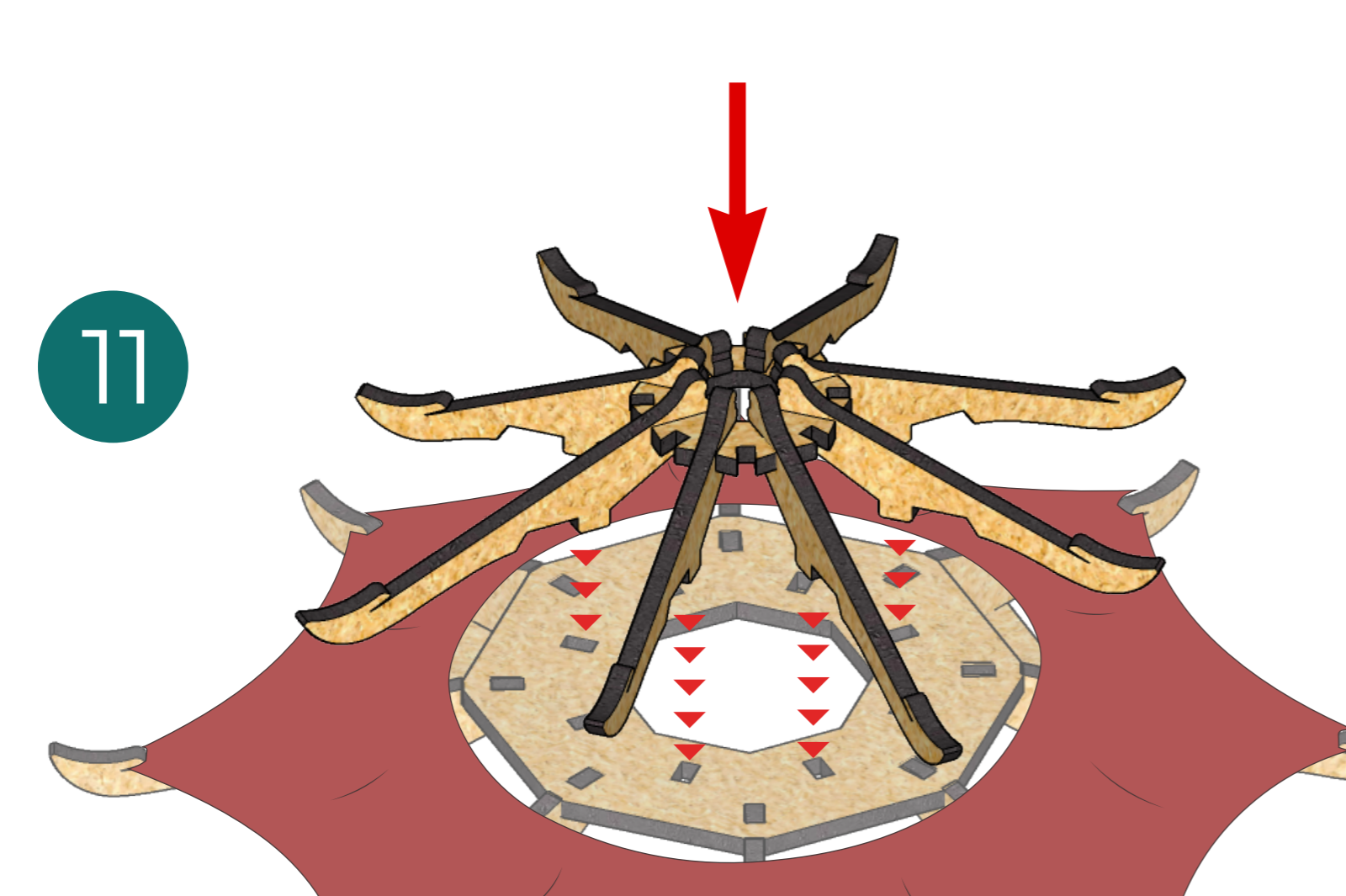
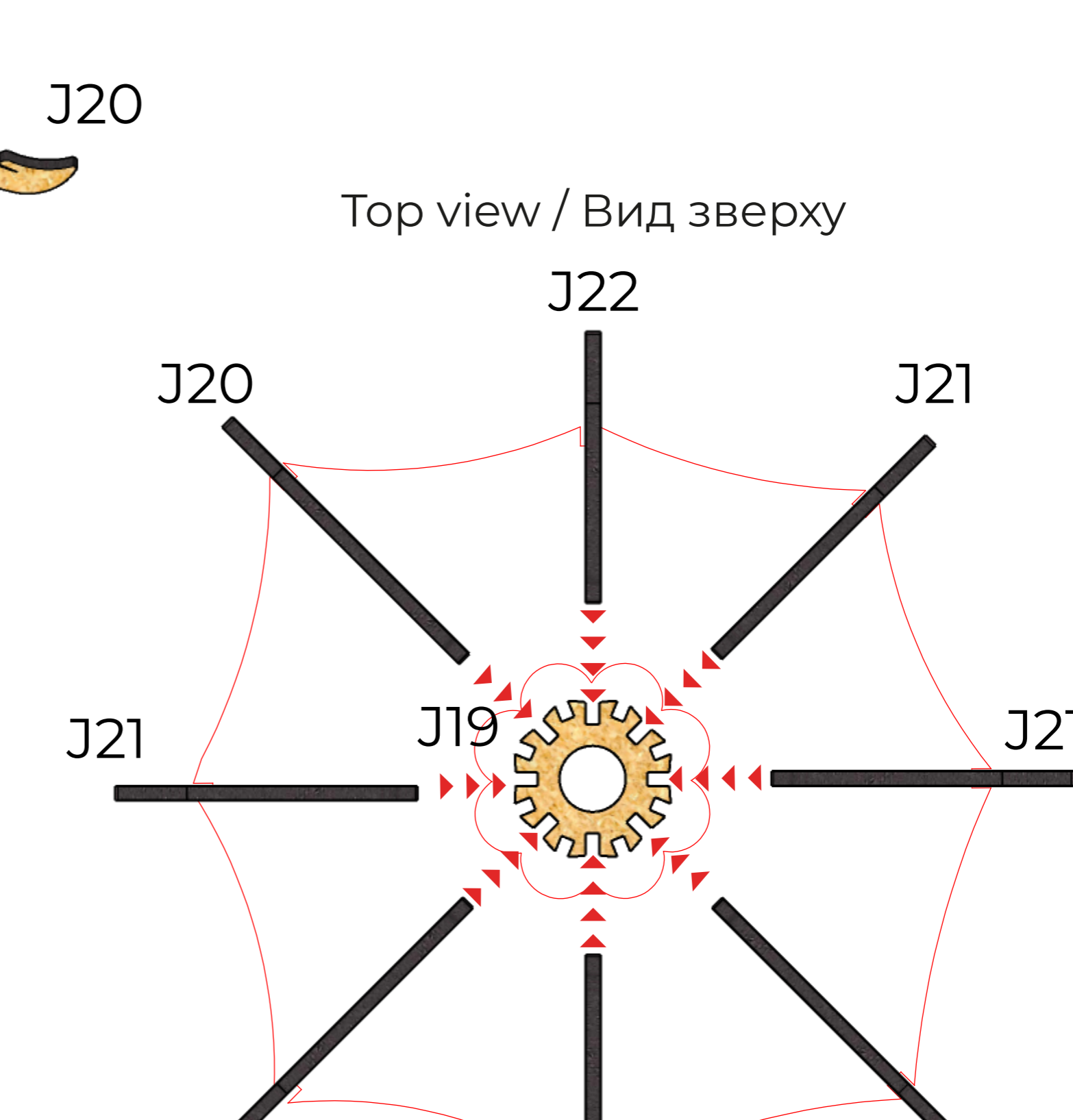

The J23 details are interchangeable and can be positioned in any configuration.
Деталі J23 взаємозамінні і можуть розташовуватись в будь-якій послідовності.

