

Mage Shop Terrain

IT IS RECOMMENDED TO USE GLUE

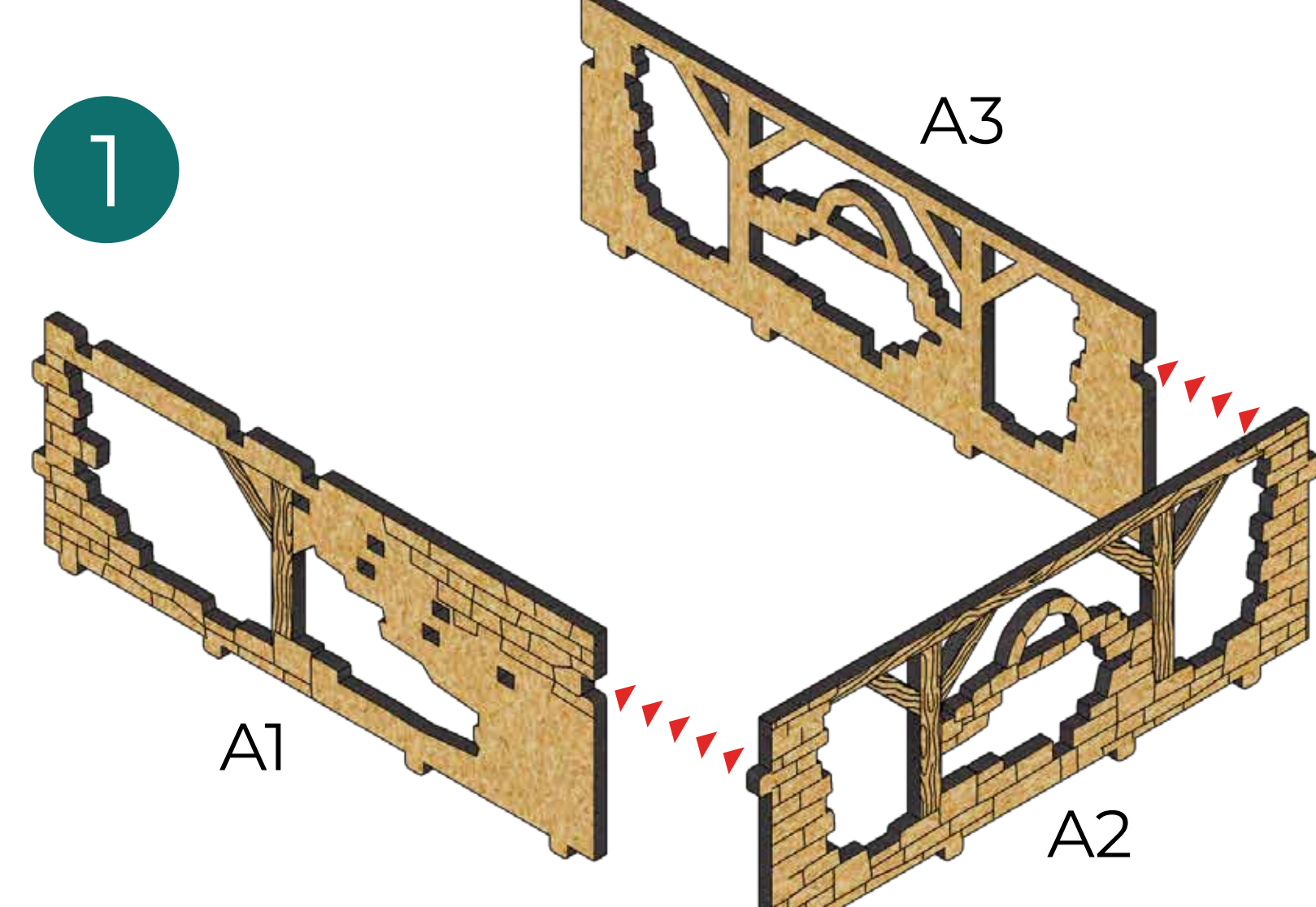

A



Be careful with parts A1-A3. Don't apply too much force to them.

Будьте обережні з деталями A1-A3. Не прикладайте до них занадто багато сили.

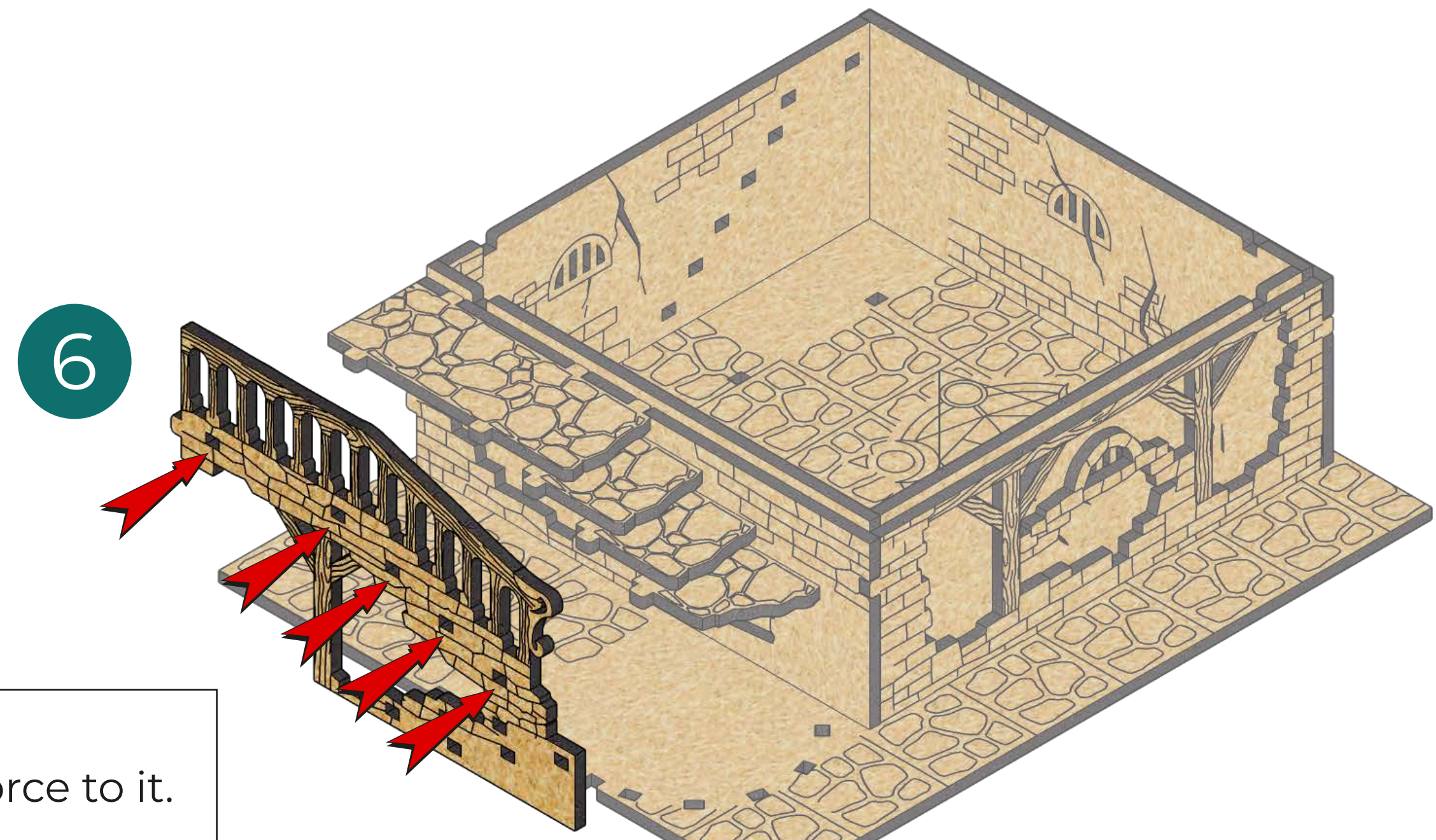
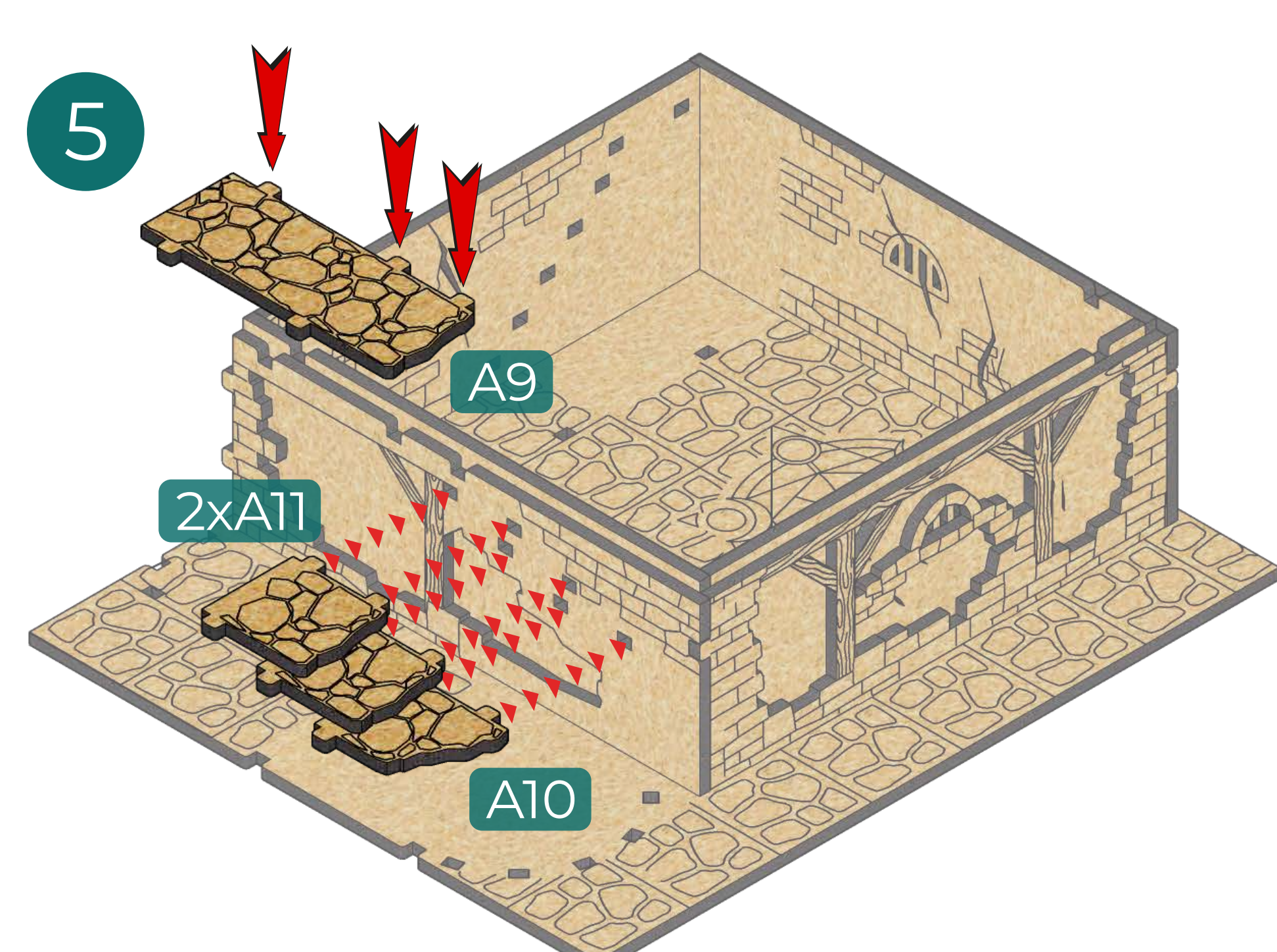
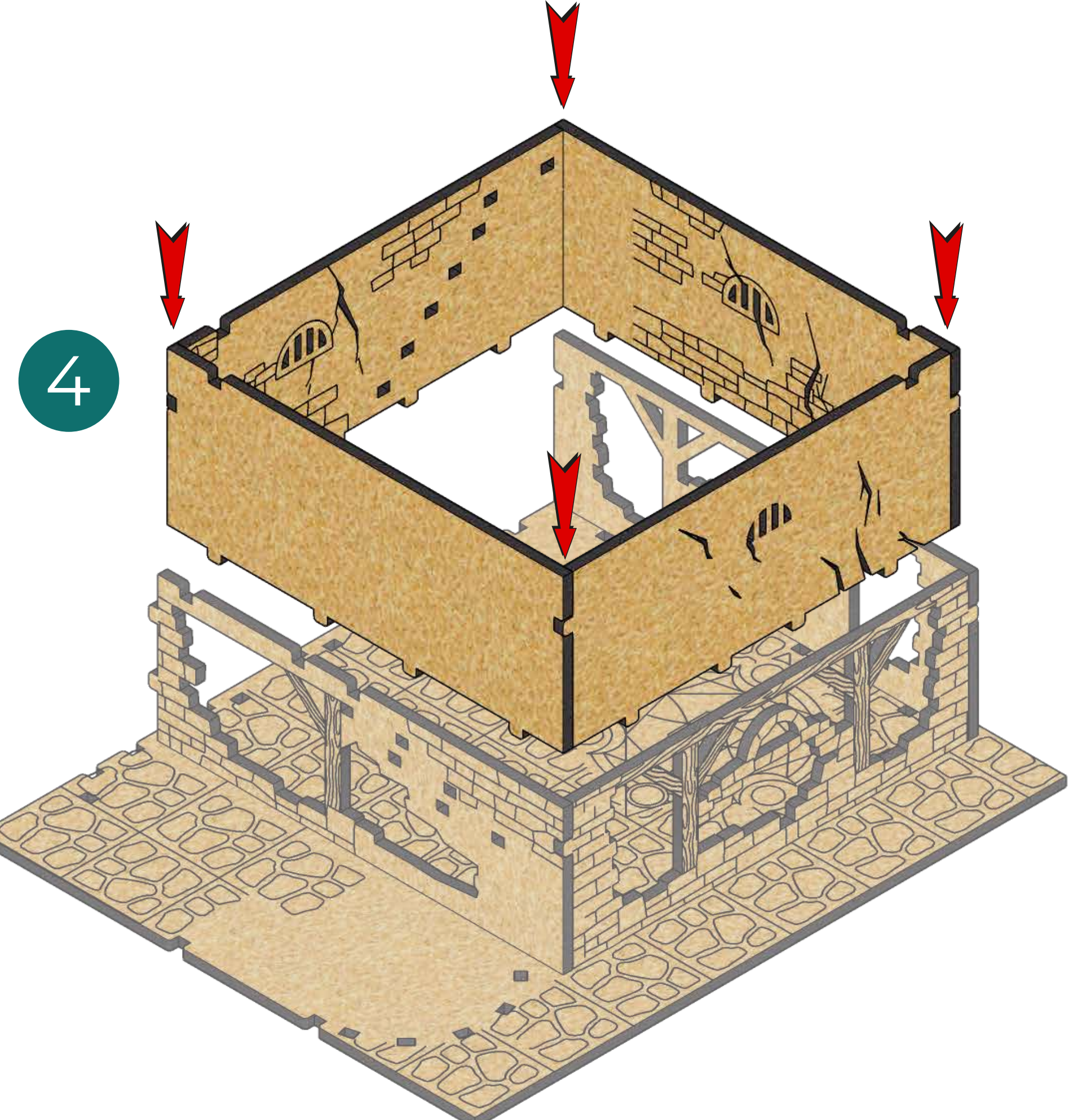
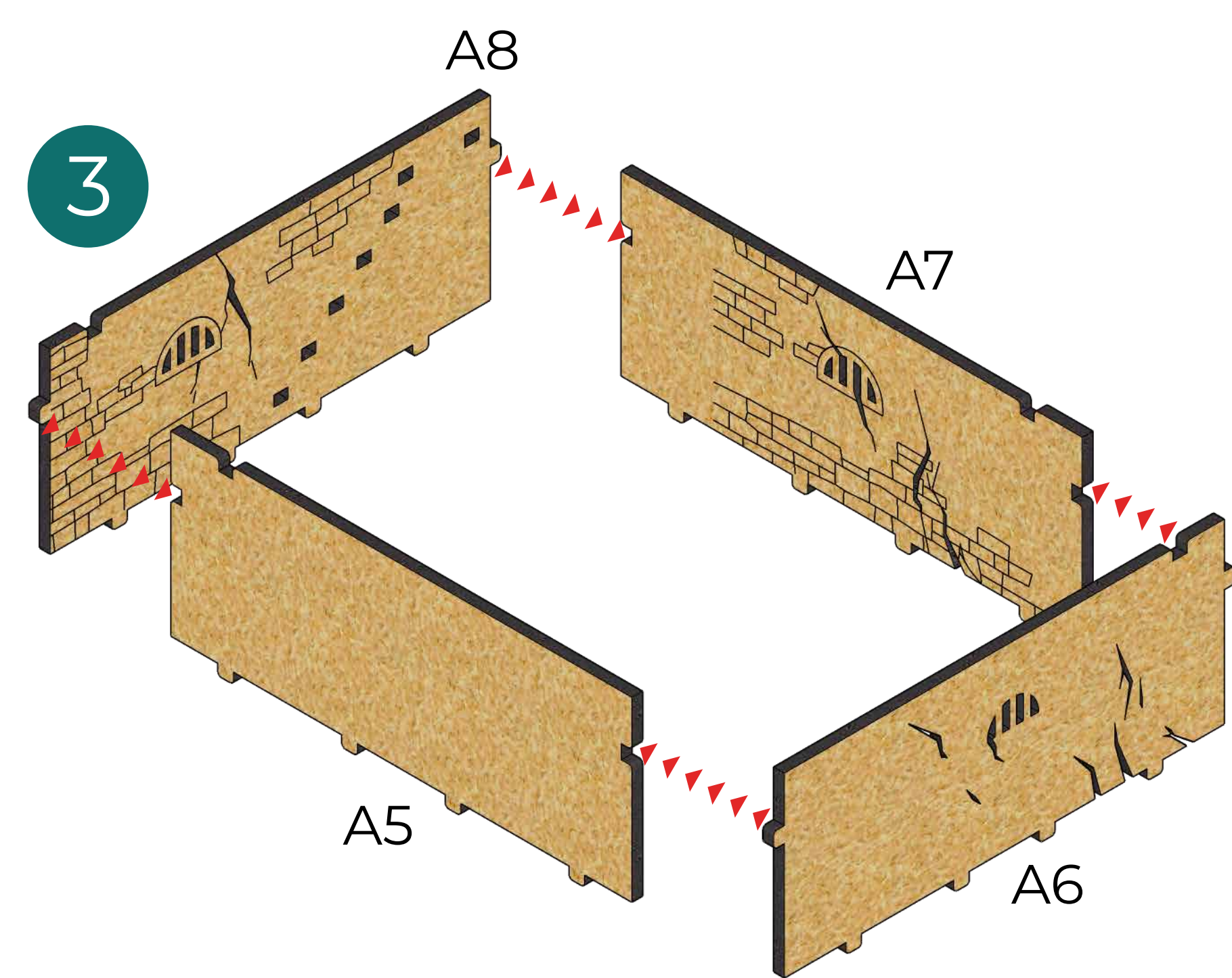
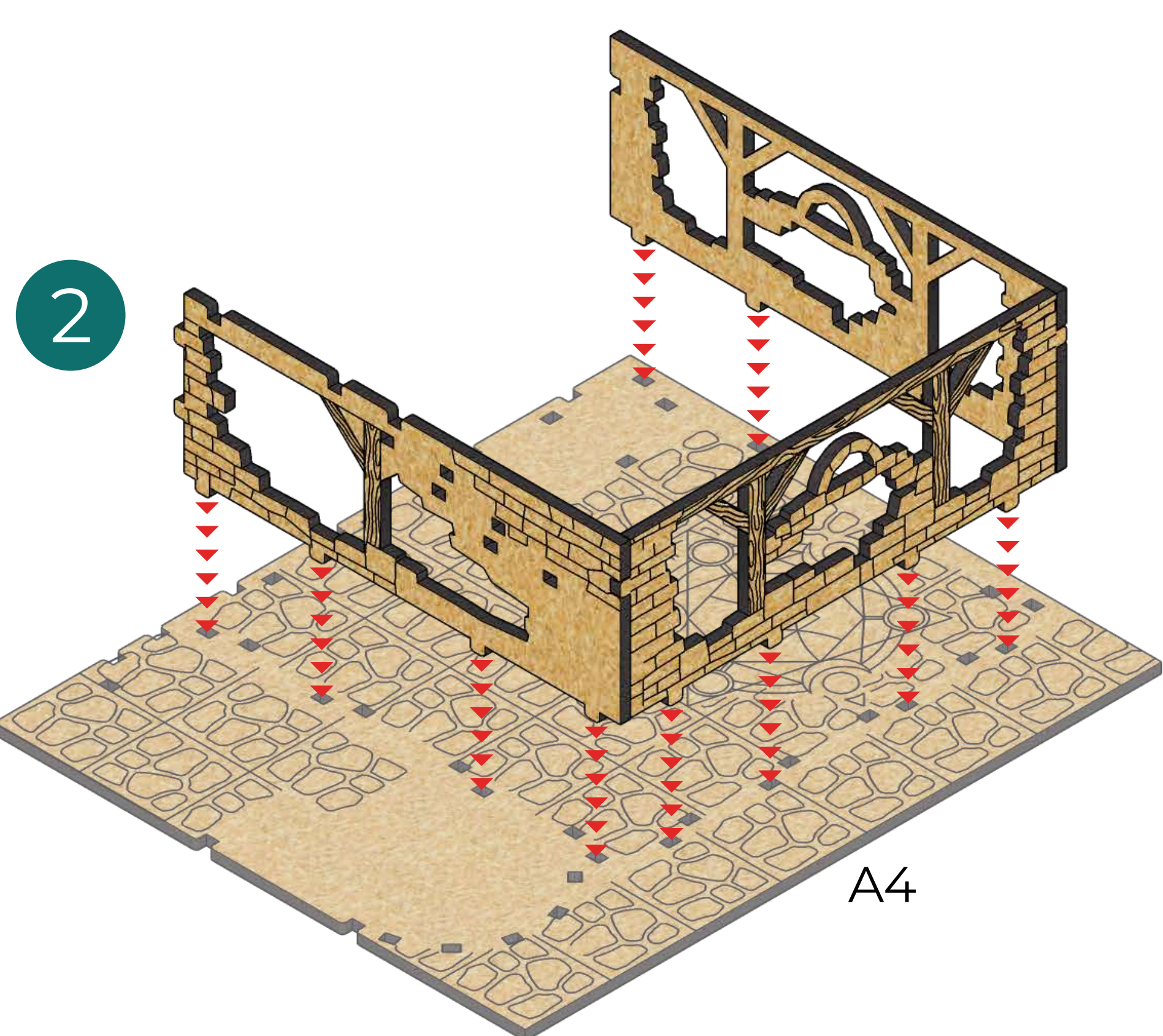

Be careful with part A12. Don't apply too much force to it.

Будьте обережні з деталлю A12. Не прикладайте до неї занадто багато сили.

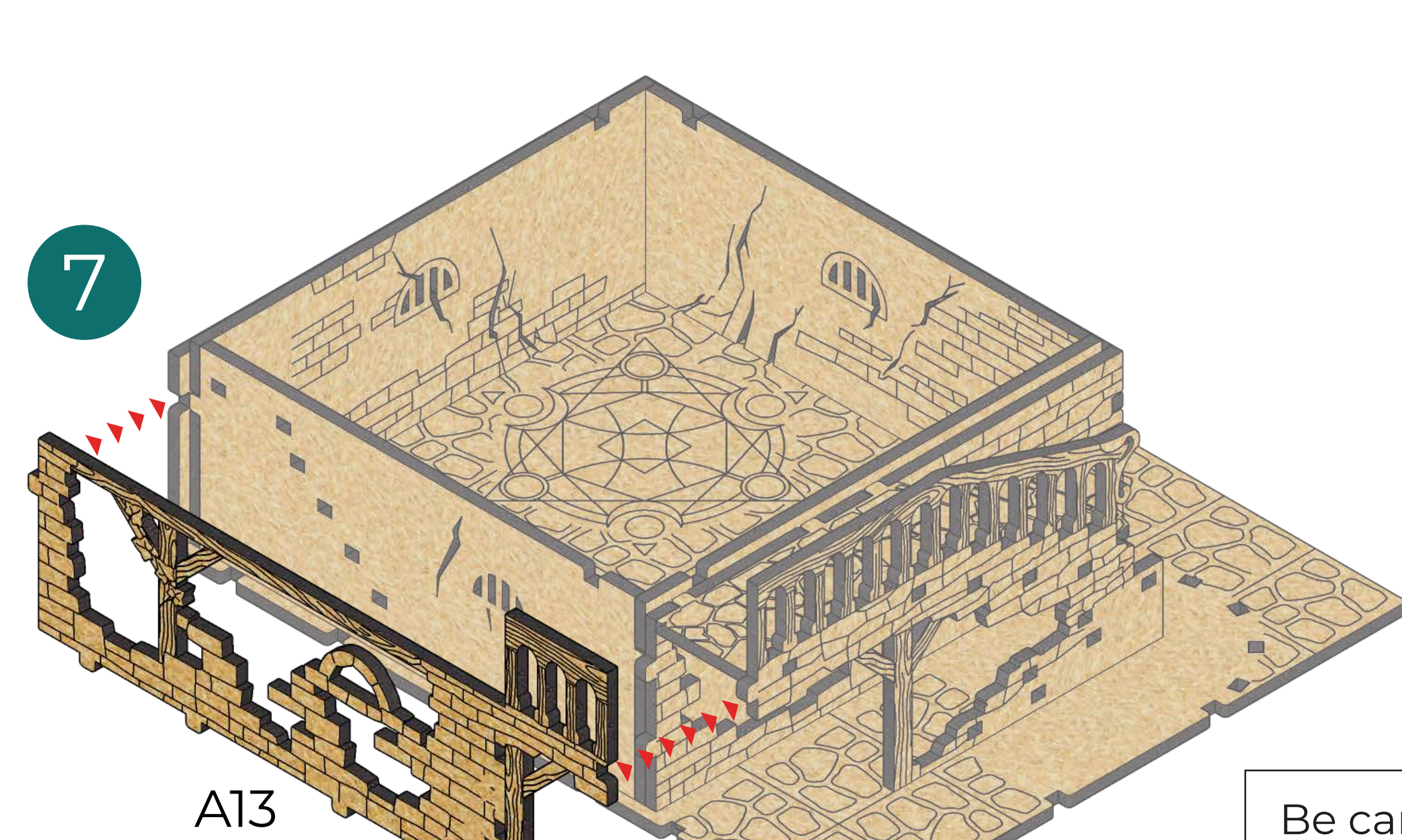

Be careful with part A13. Don't apply too much force to it.

Будьте обережні з деталлю A13. Не прикладайте до неї занадто багато сили.

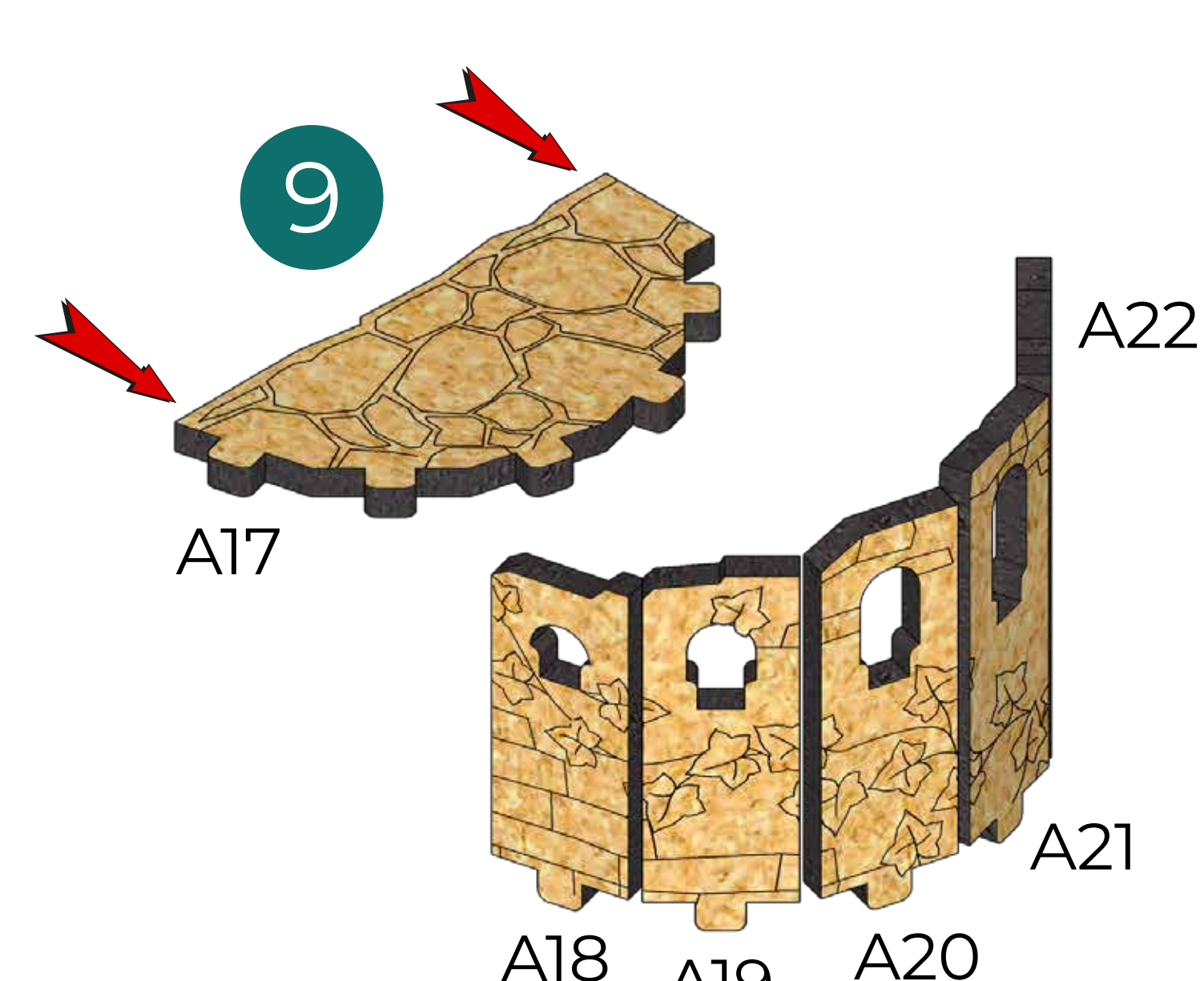
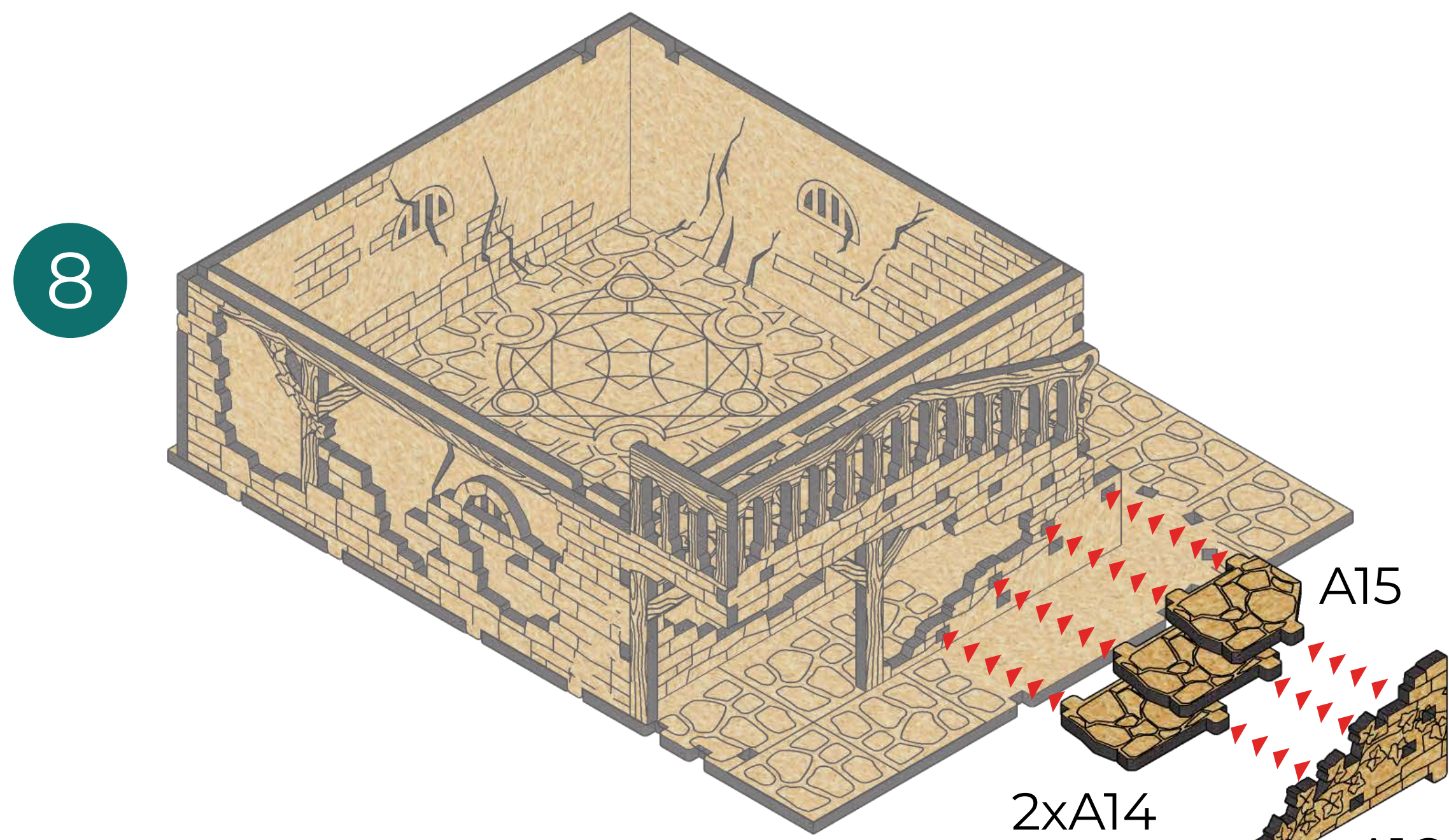

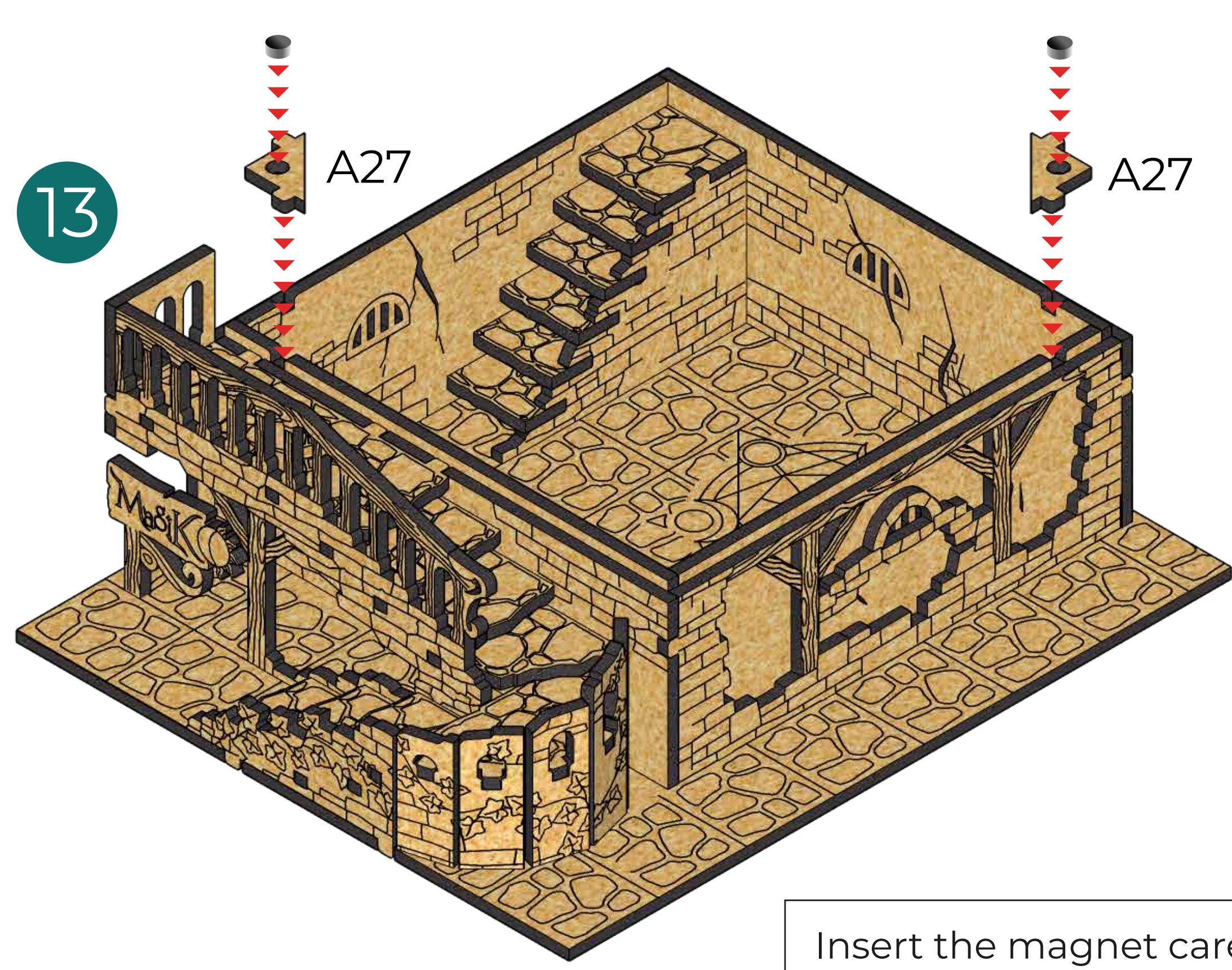
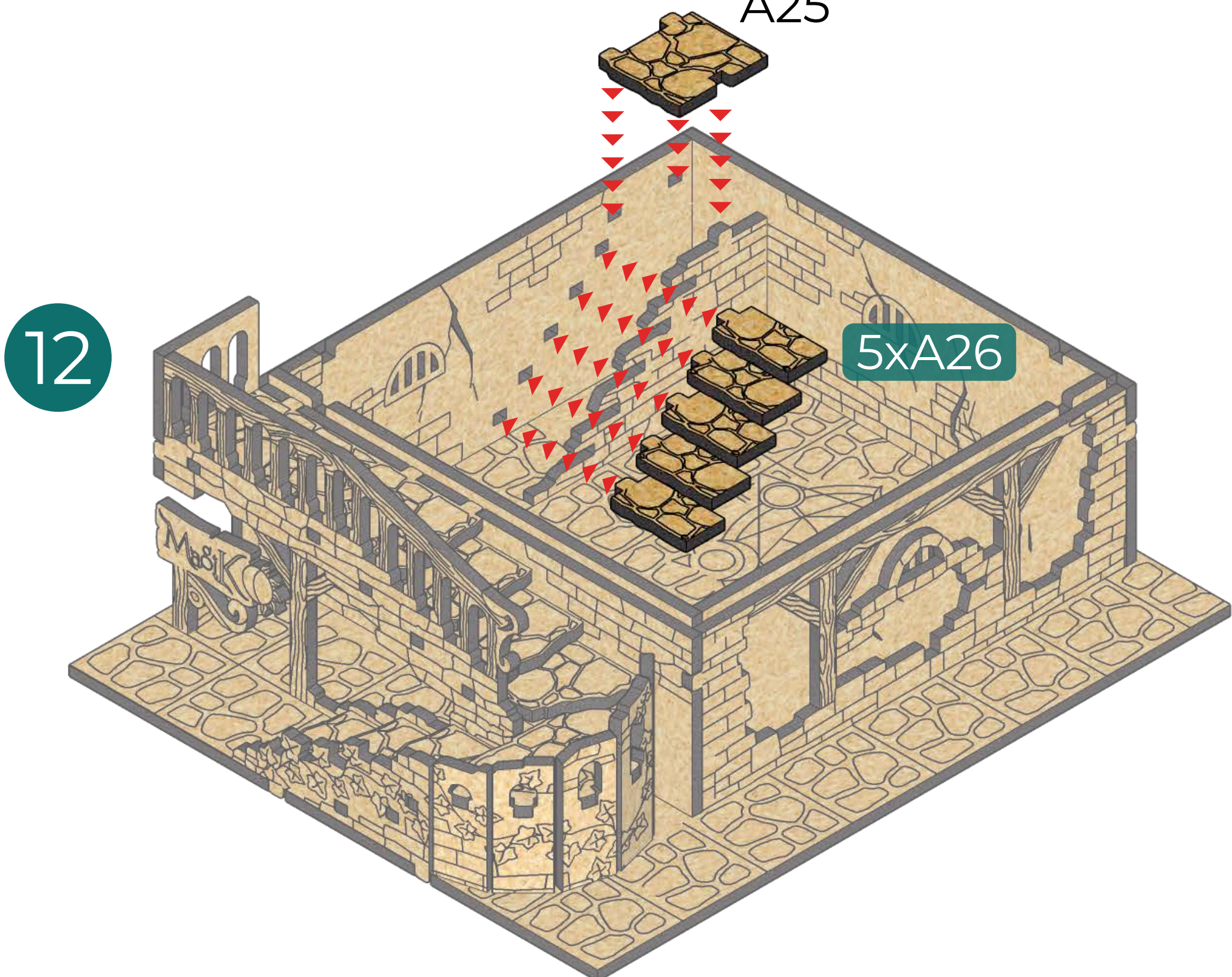
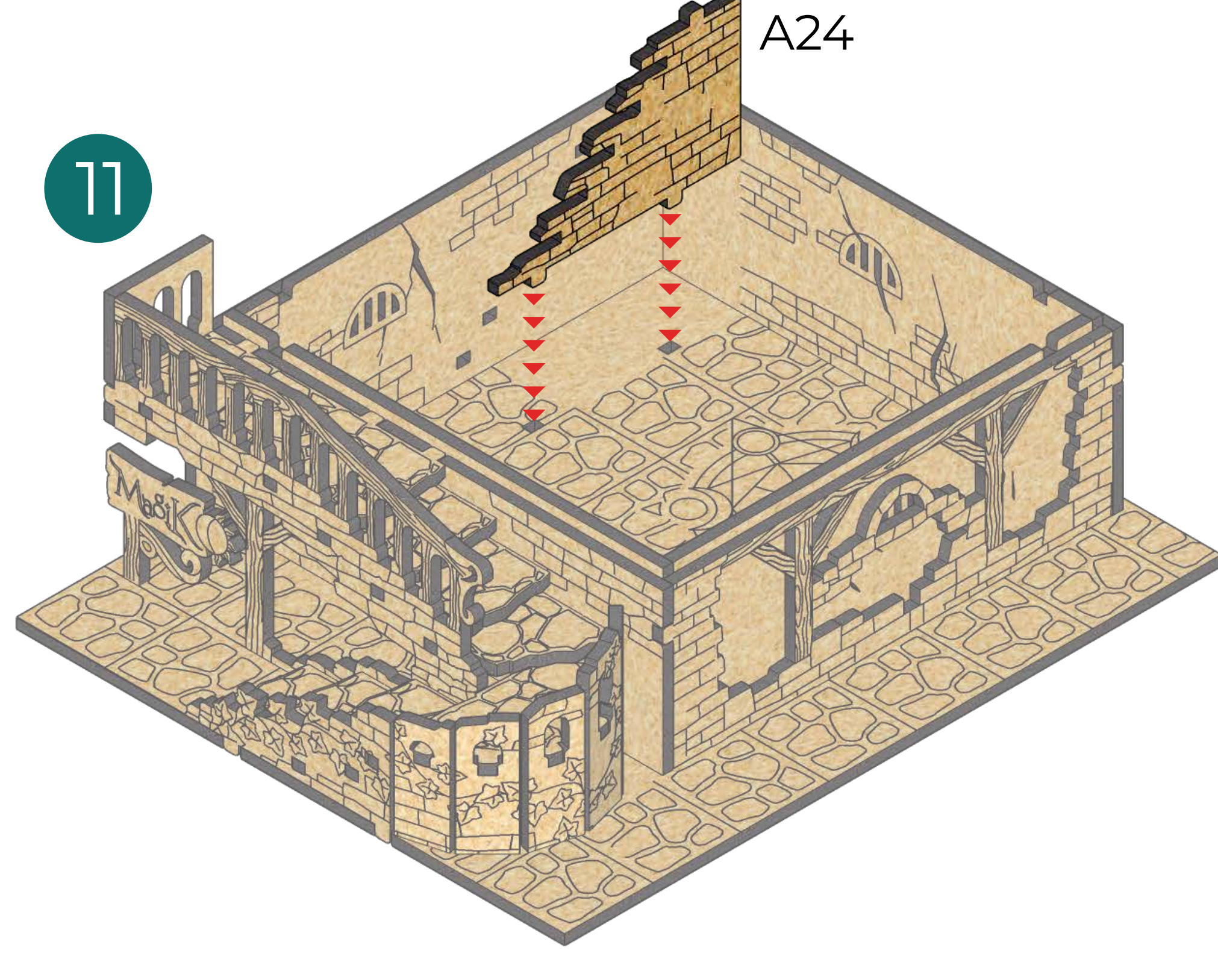
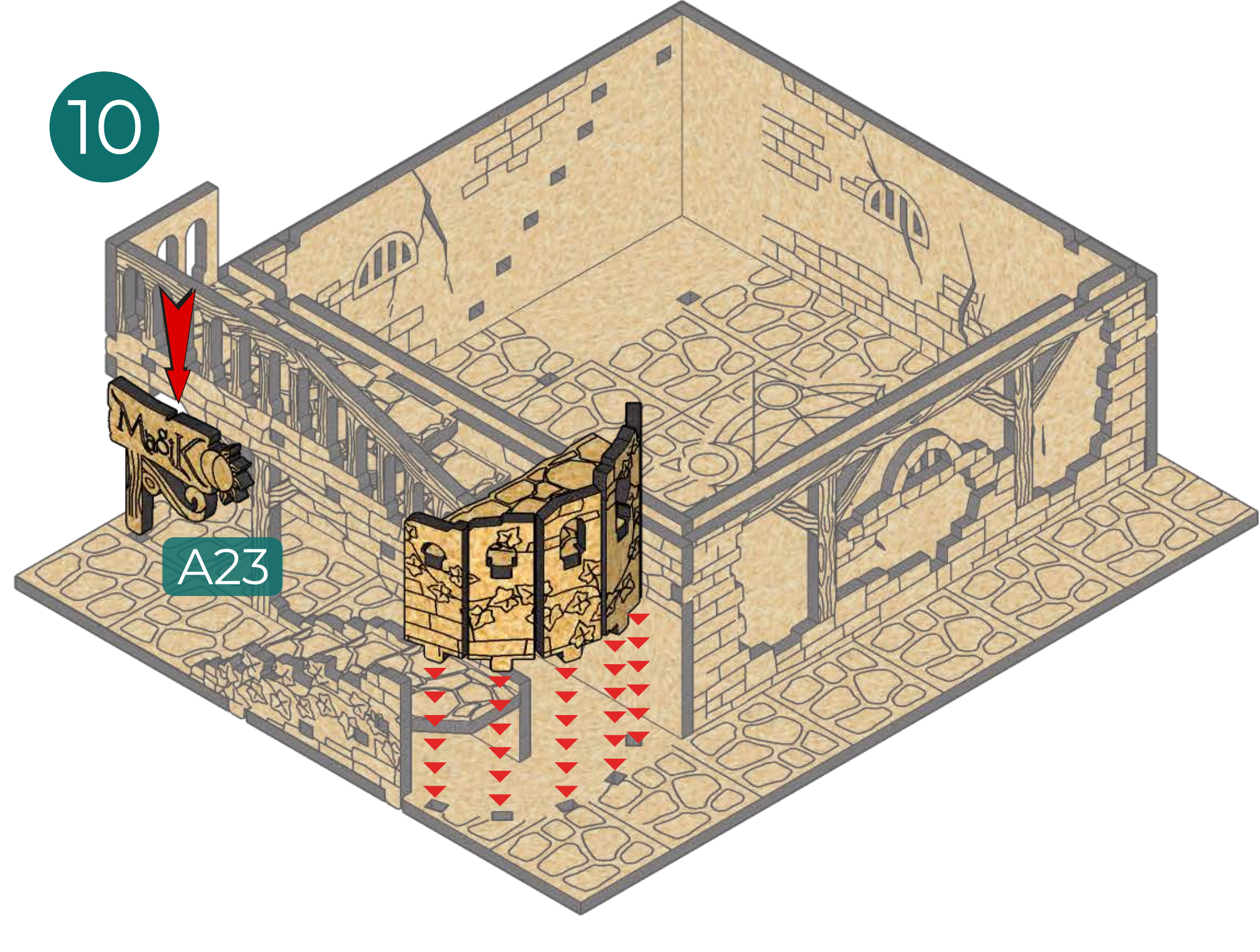

Insert the magnet carefully and check its polarity so that the other magnet can be magnetized to it from above.

Вставте магніт обережно, а також перевірте його полярність таким чином, щоб до нього можна було примагнітити інший магніт зверху.

B

All parts B2-B4 are assembled in the same way.

Всі деталі B2-B4 складаються аналогічно.

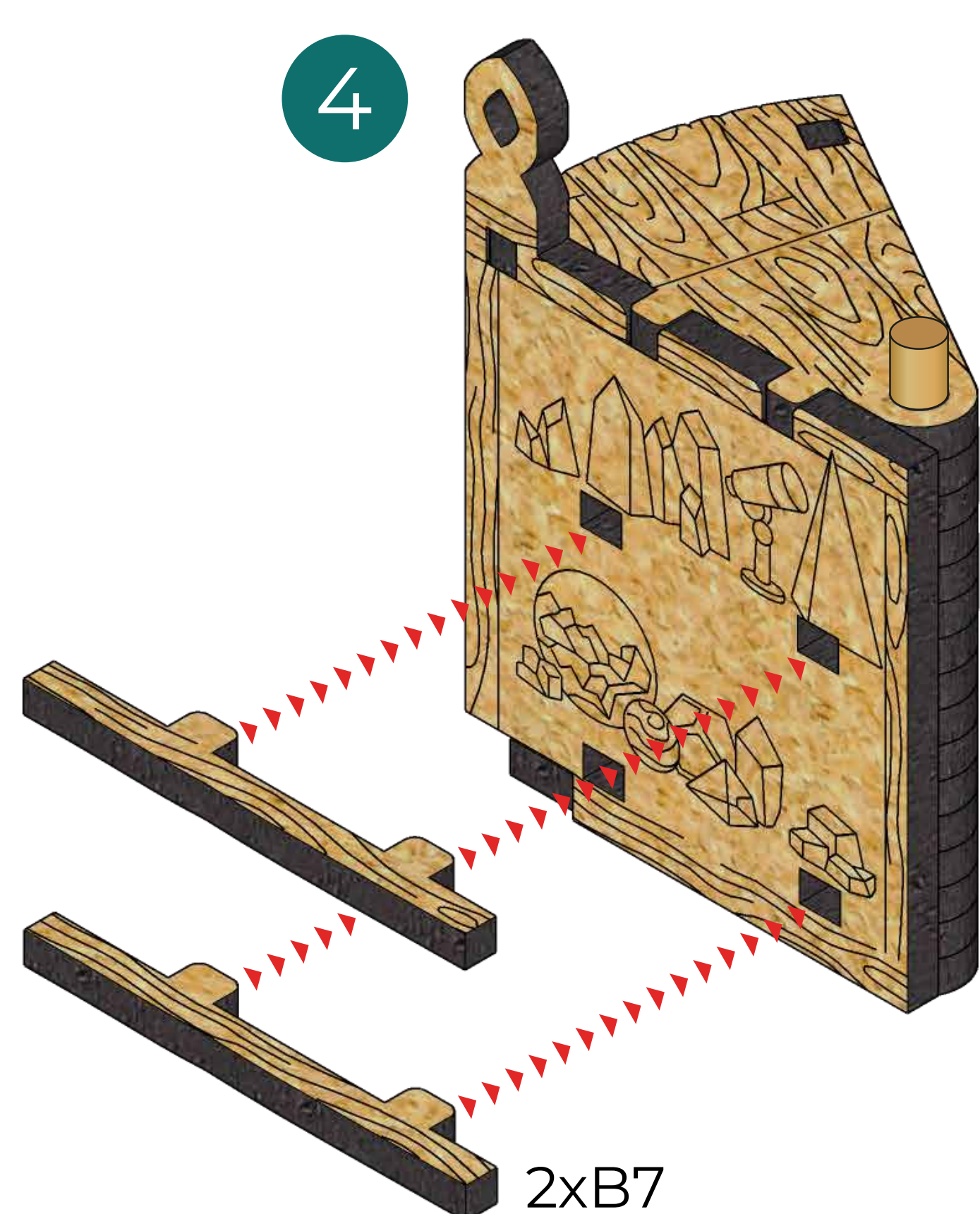
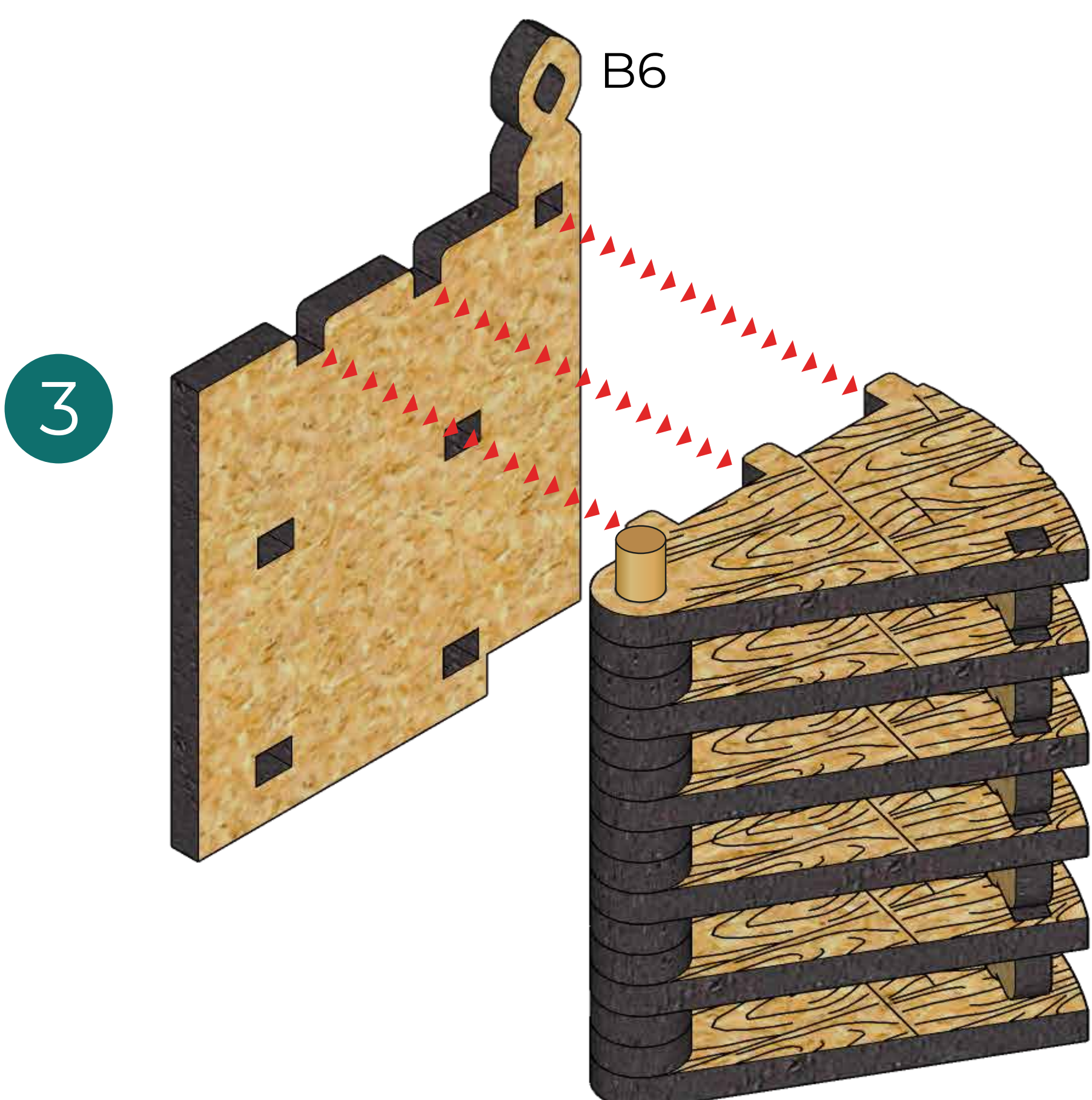
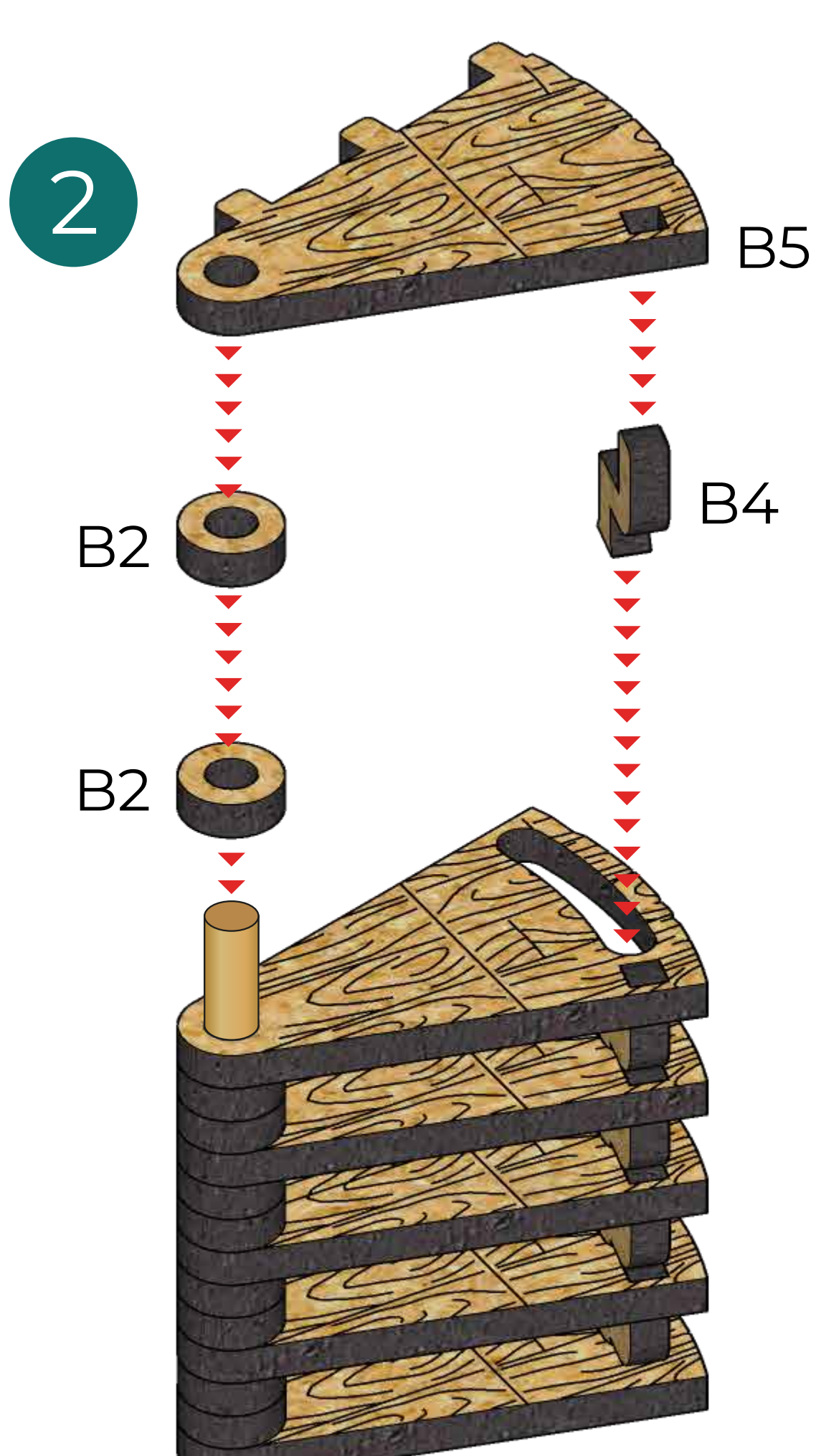
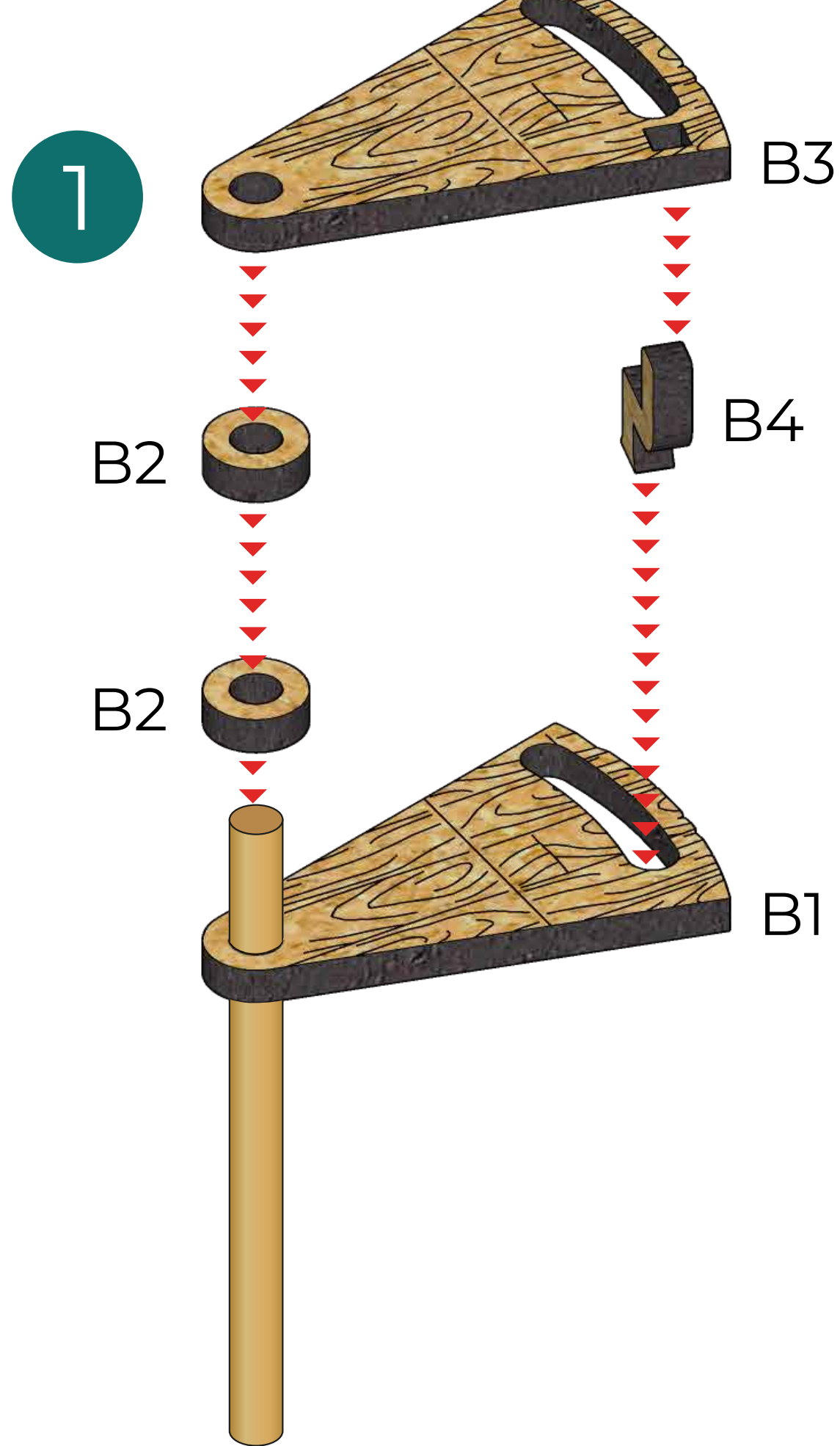

2 spare parts B4.
2 запасні деталі B4.

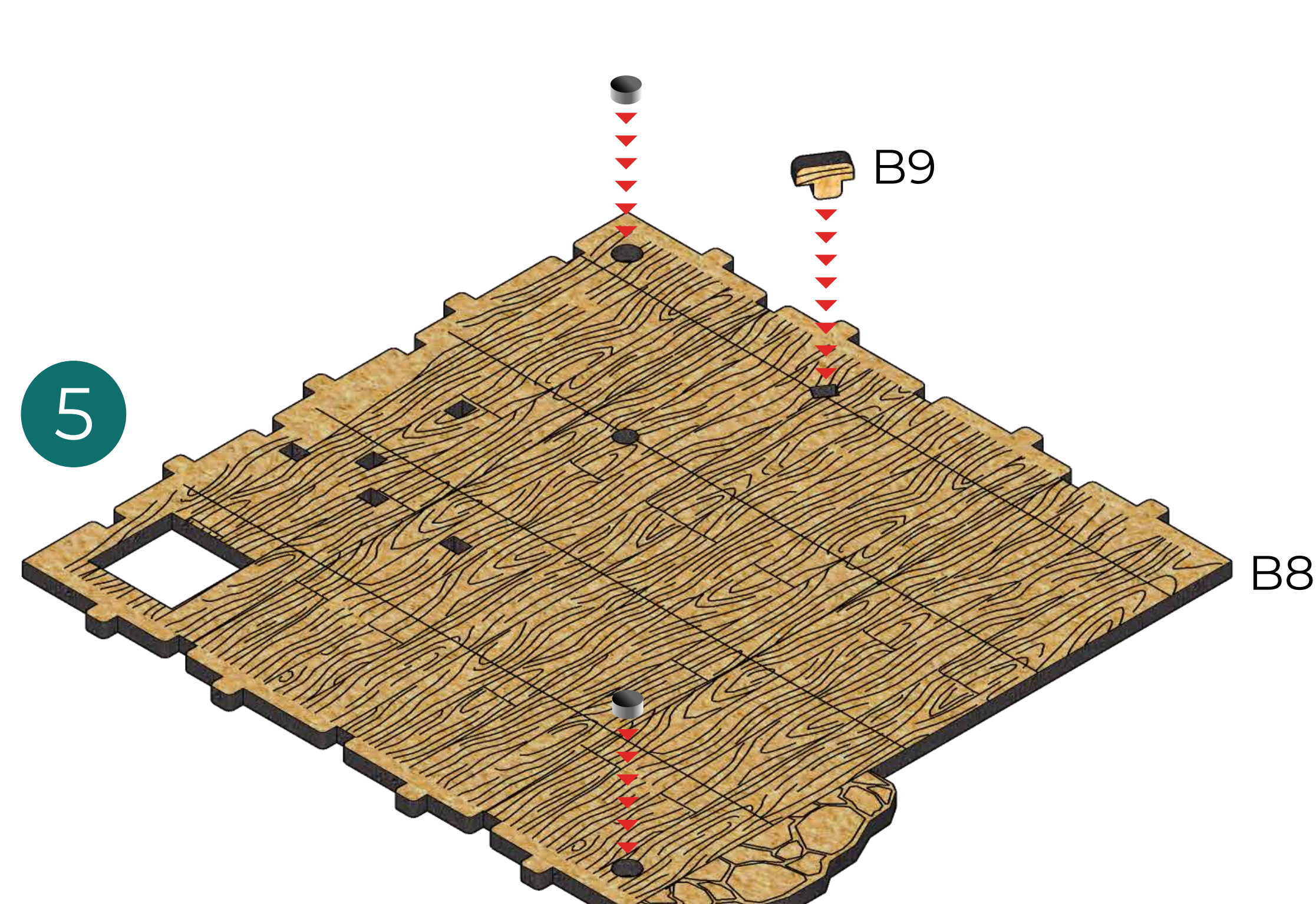

Insert the magnet carefully and check its polarity so that the other magnet can be magnetized to it from below.

Вставте магніт обережно, а також перевірте його полярність таким чином, щоб до нього можна було примагнітити інший магніт знизу.

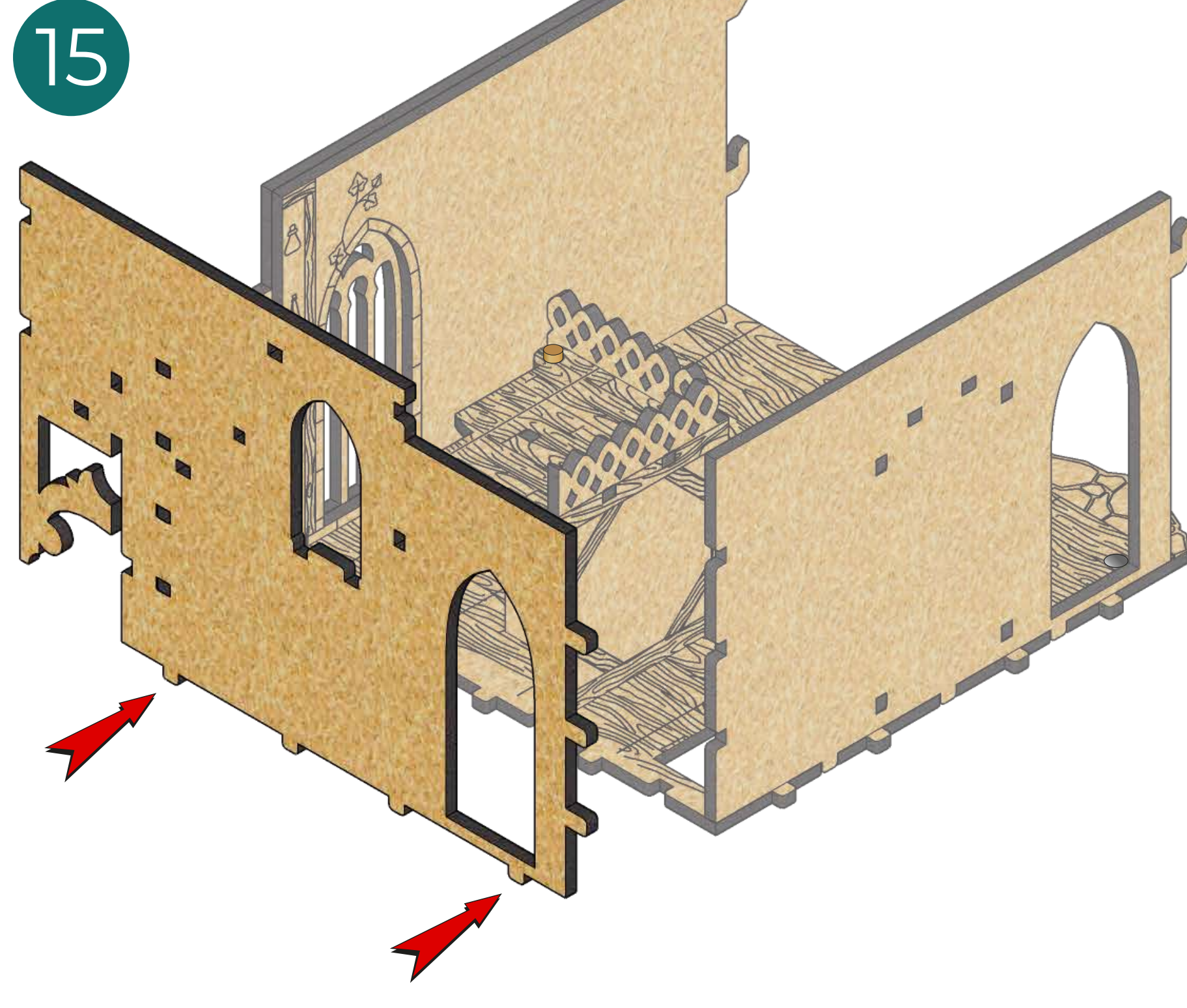
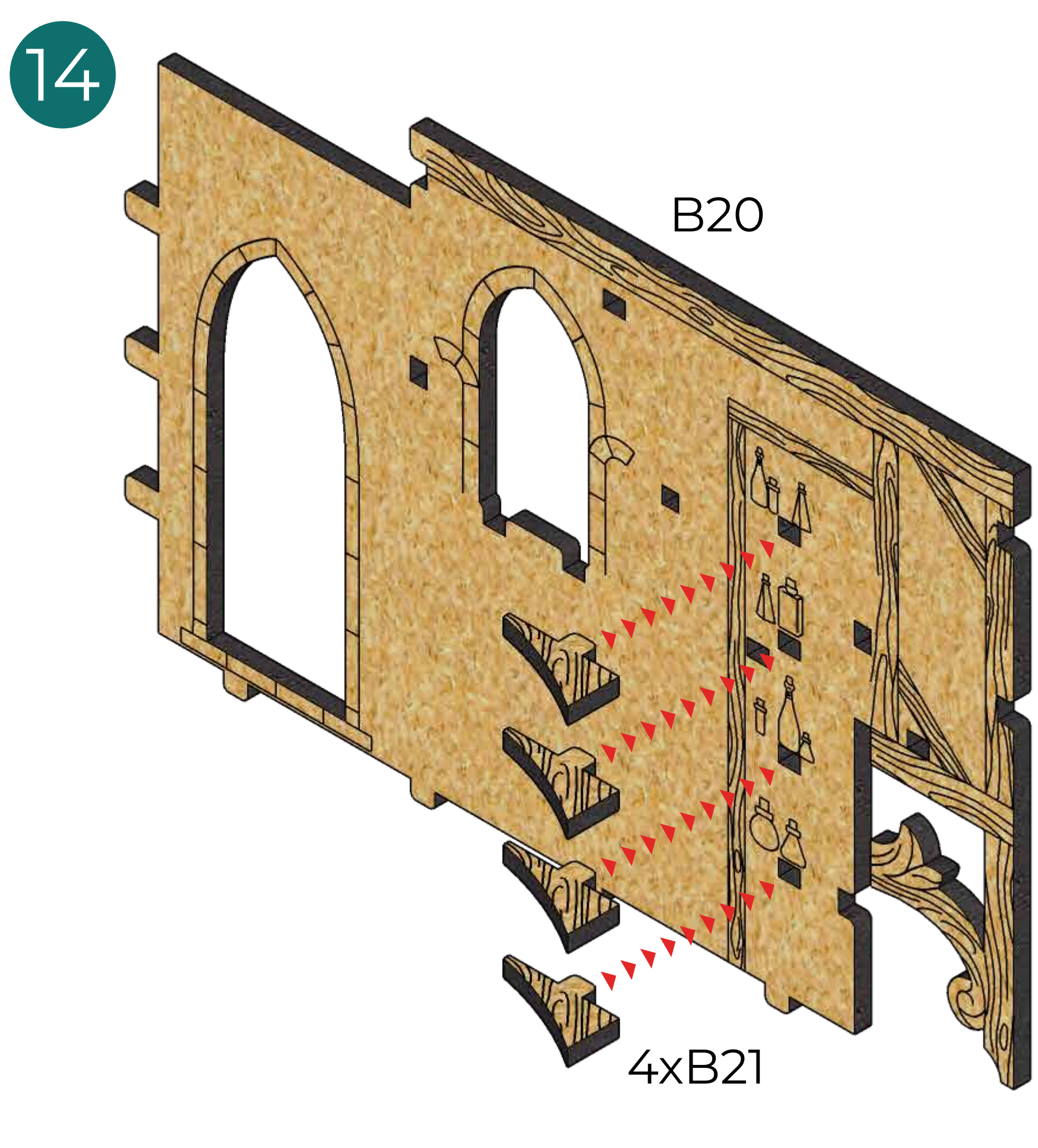
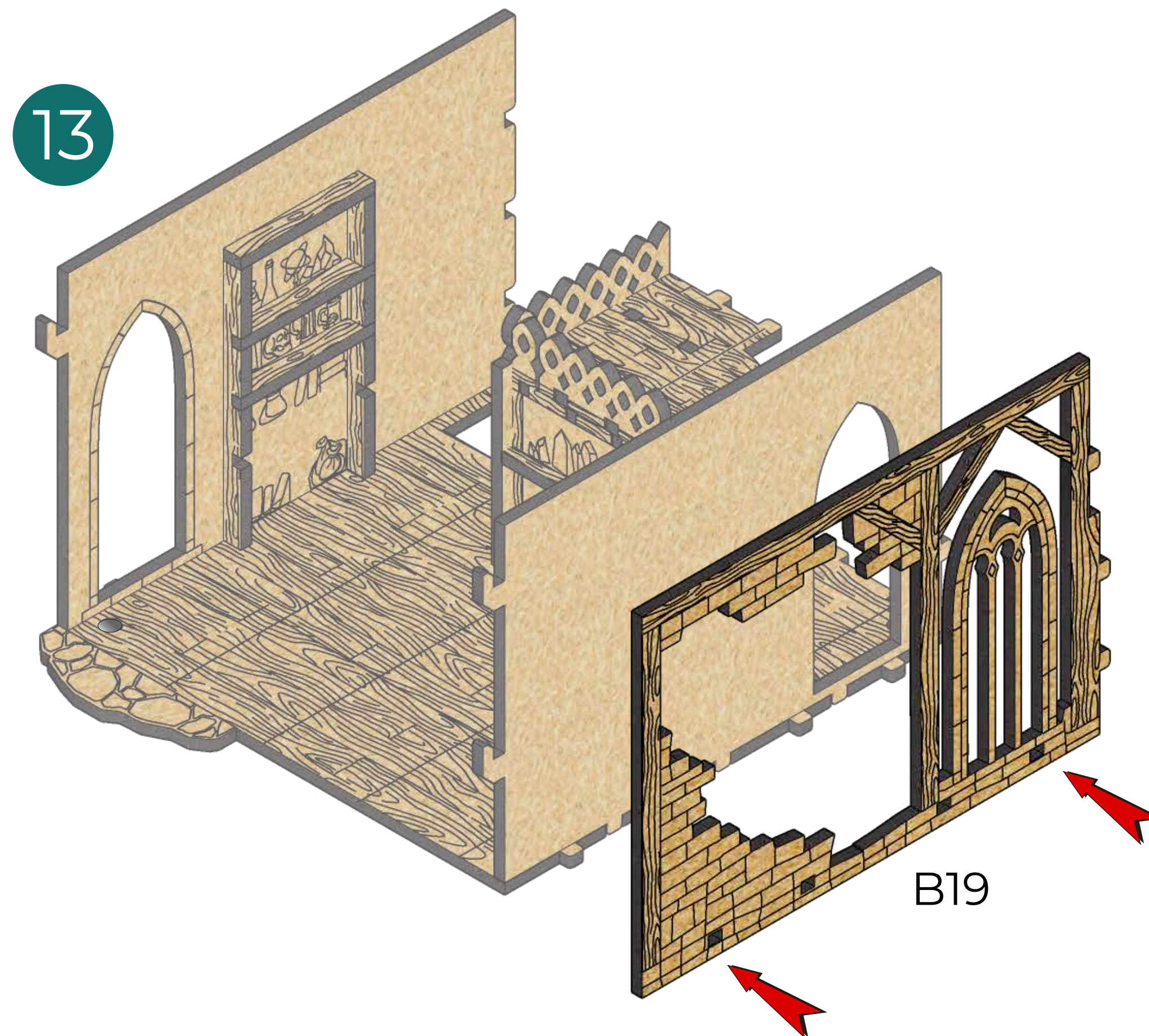
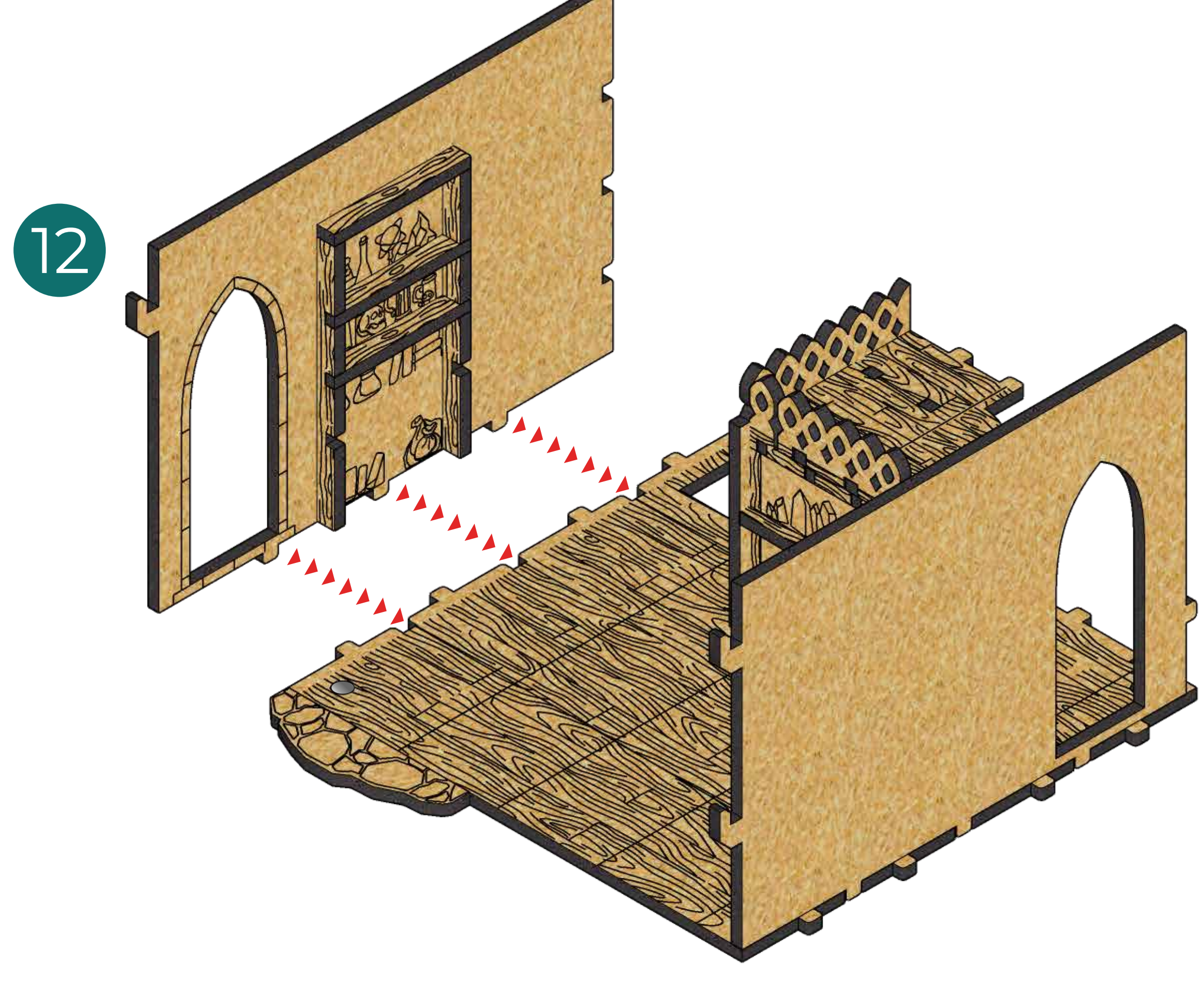
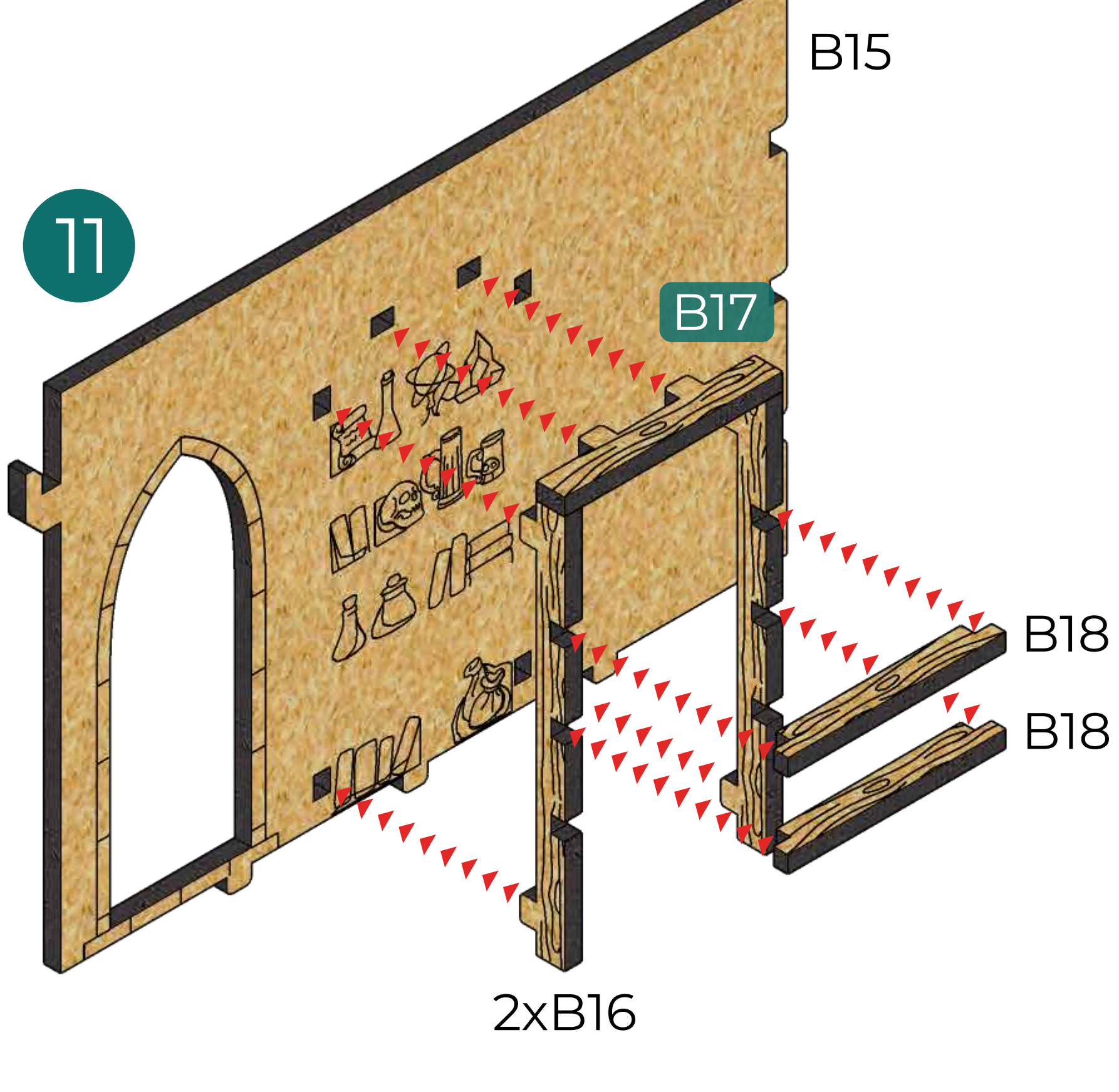
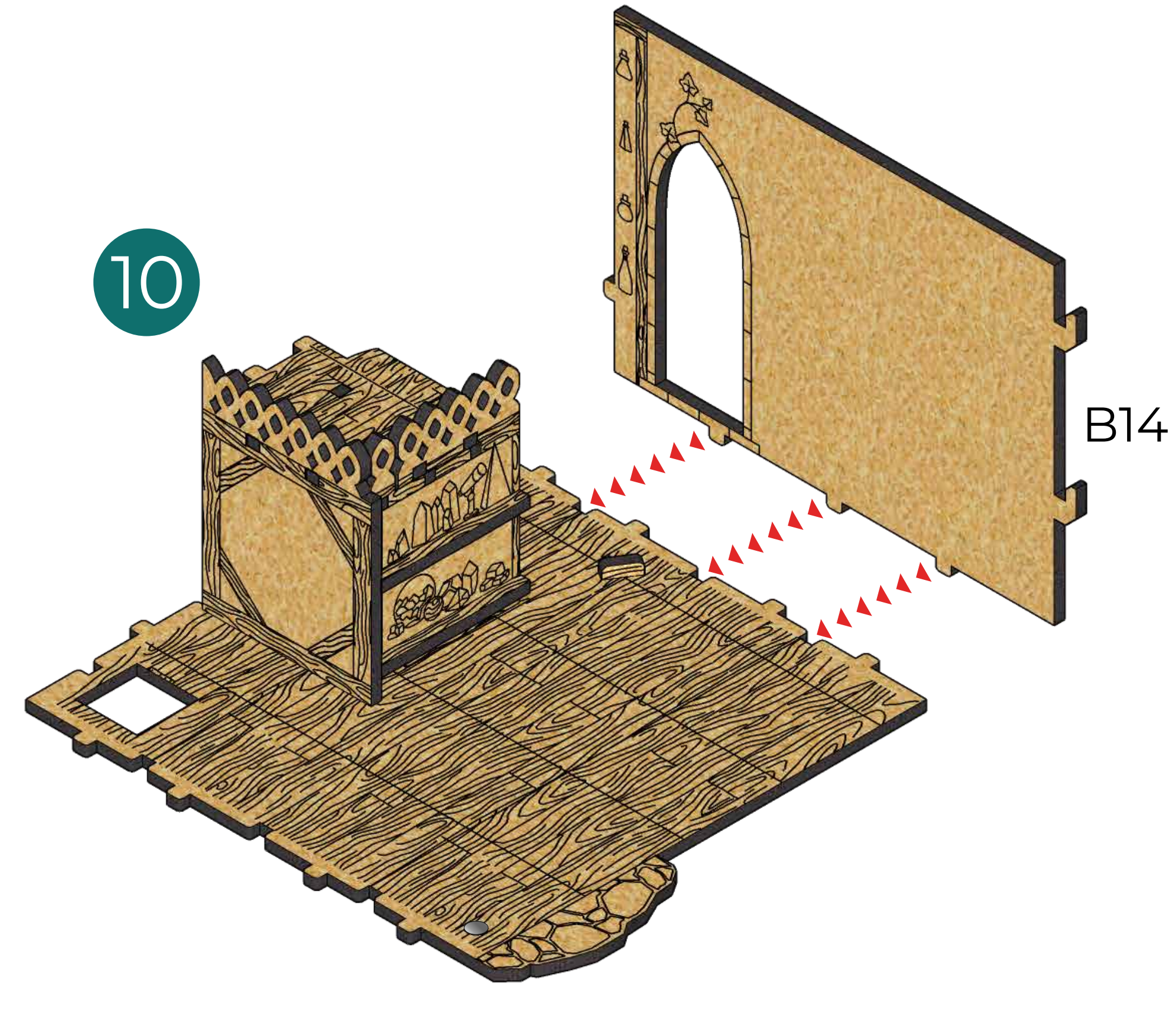
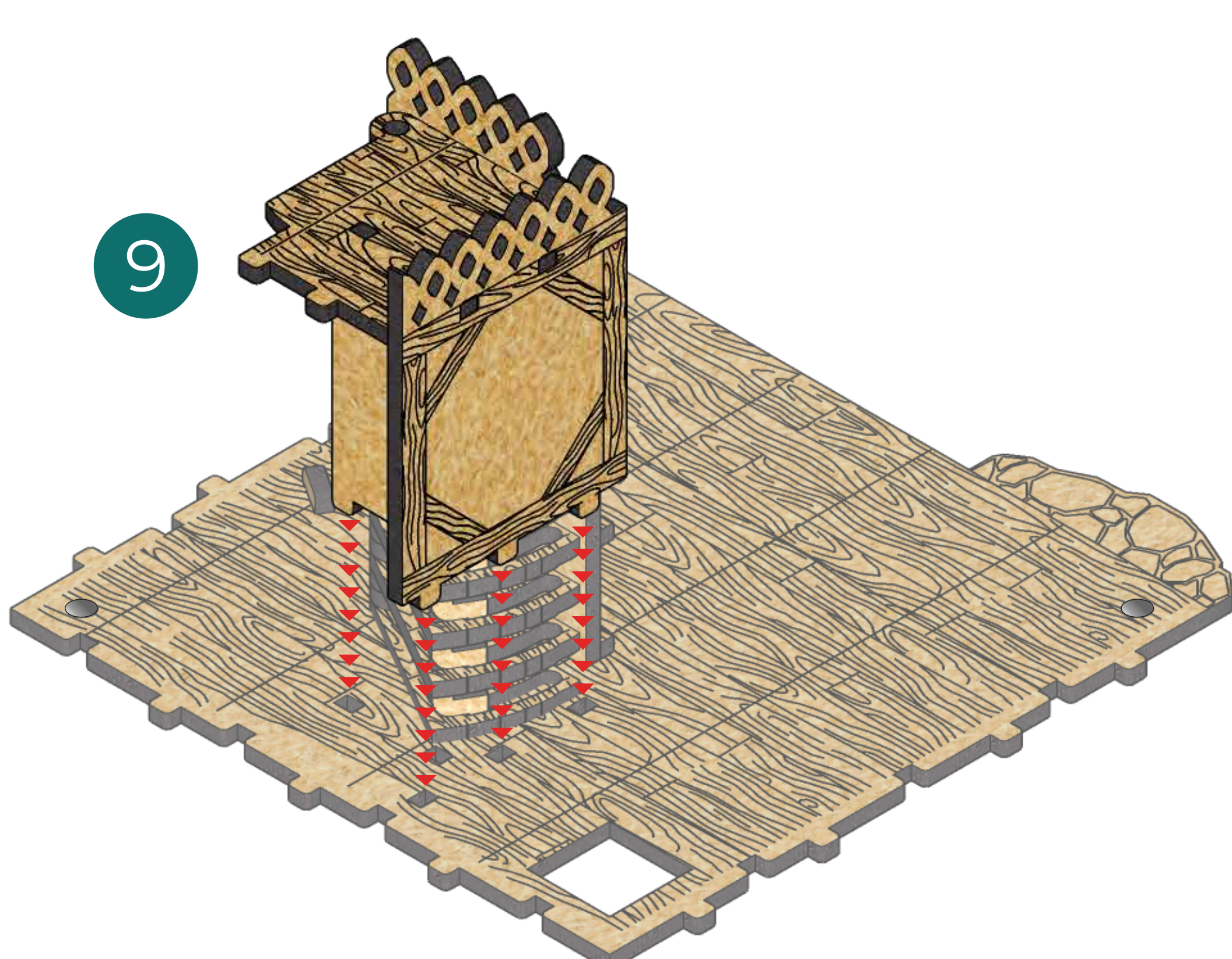
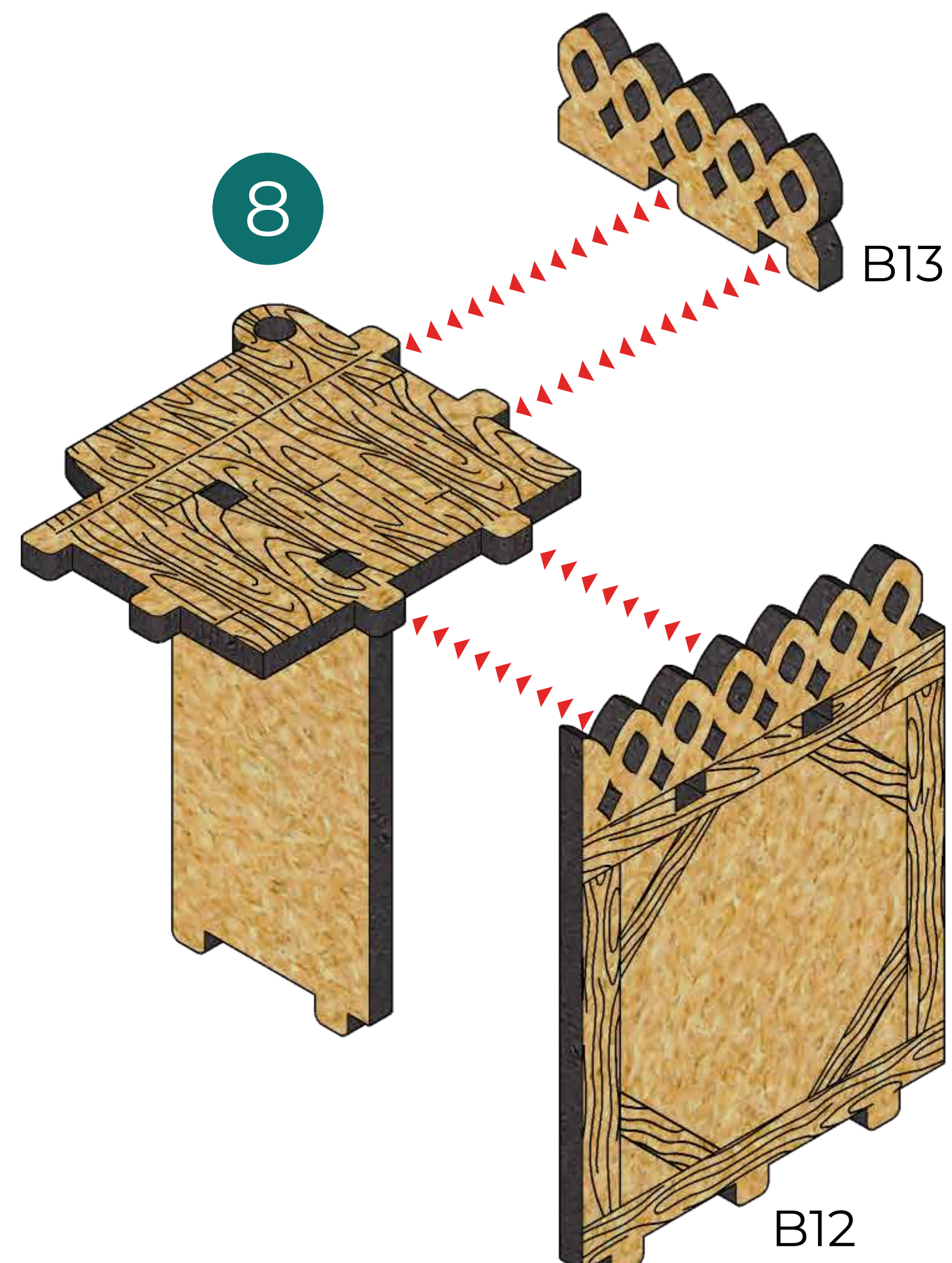
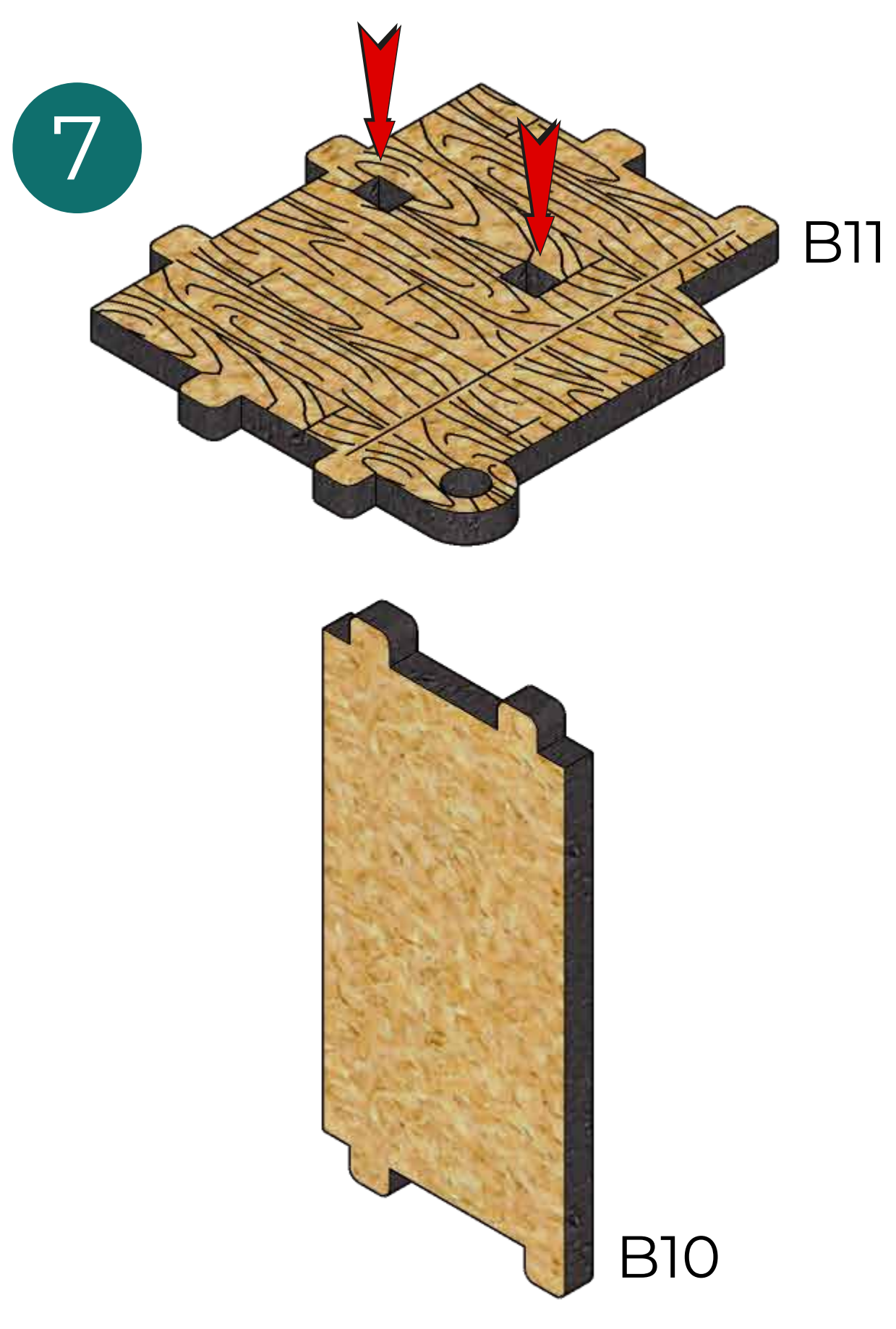
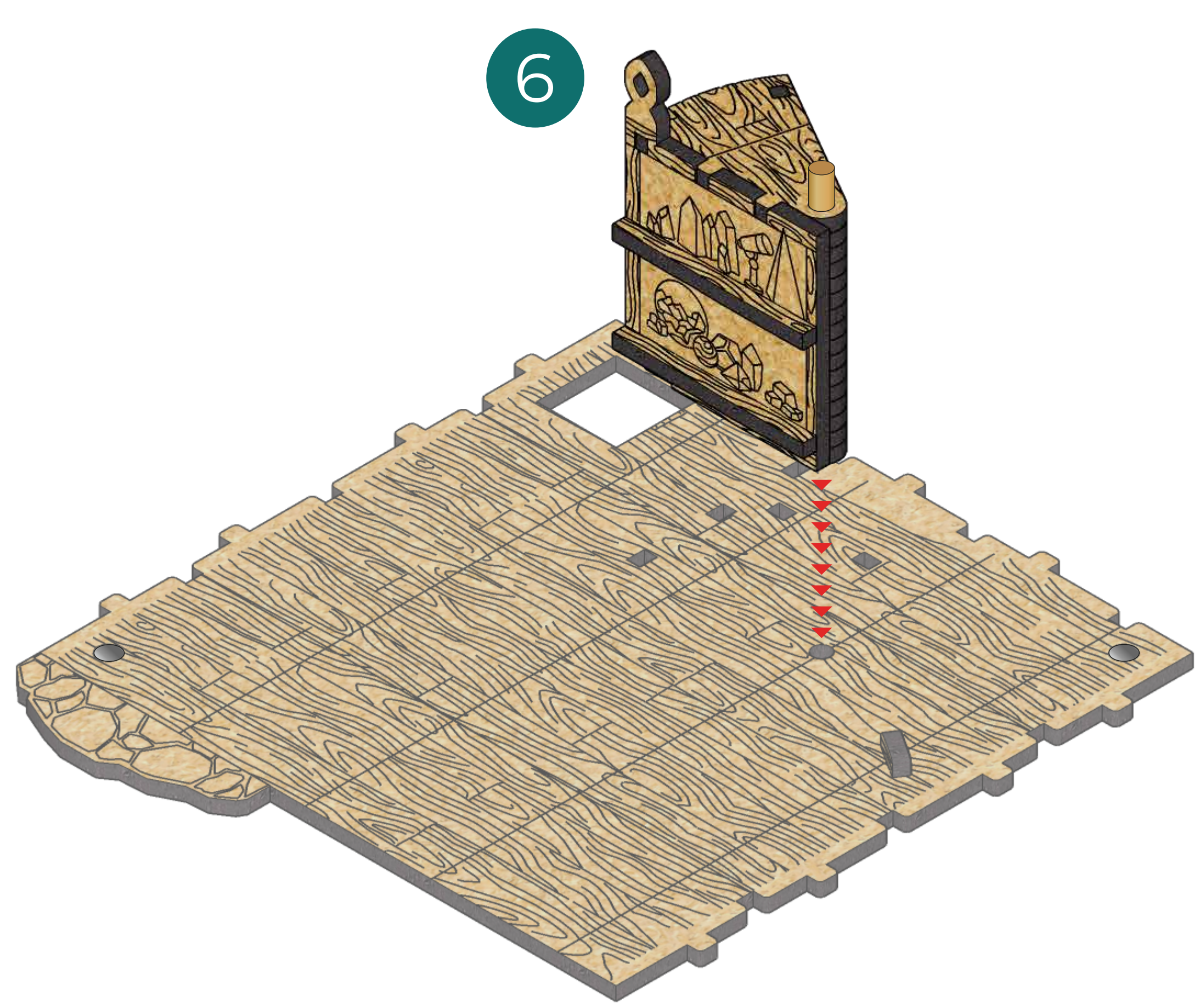

16

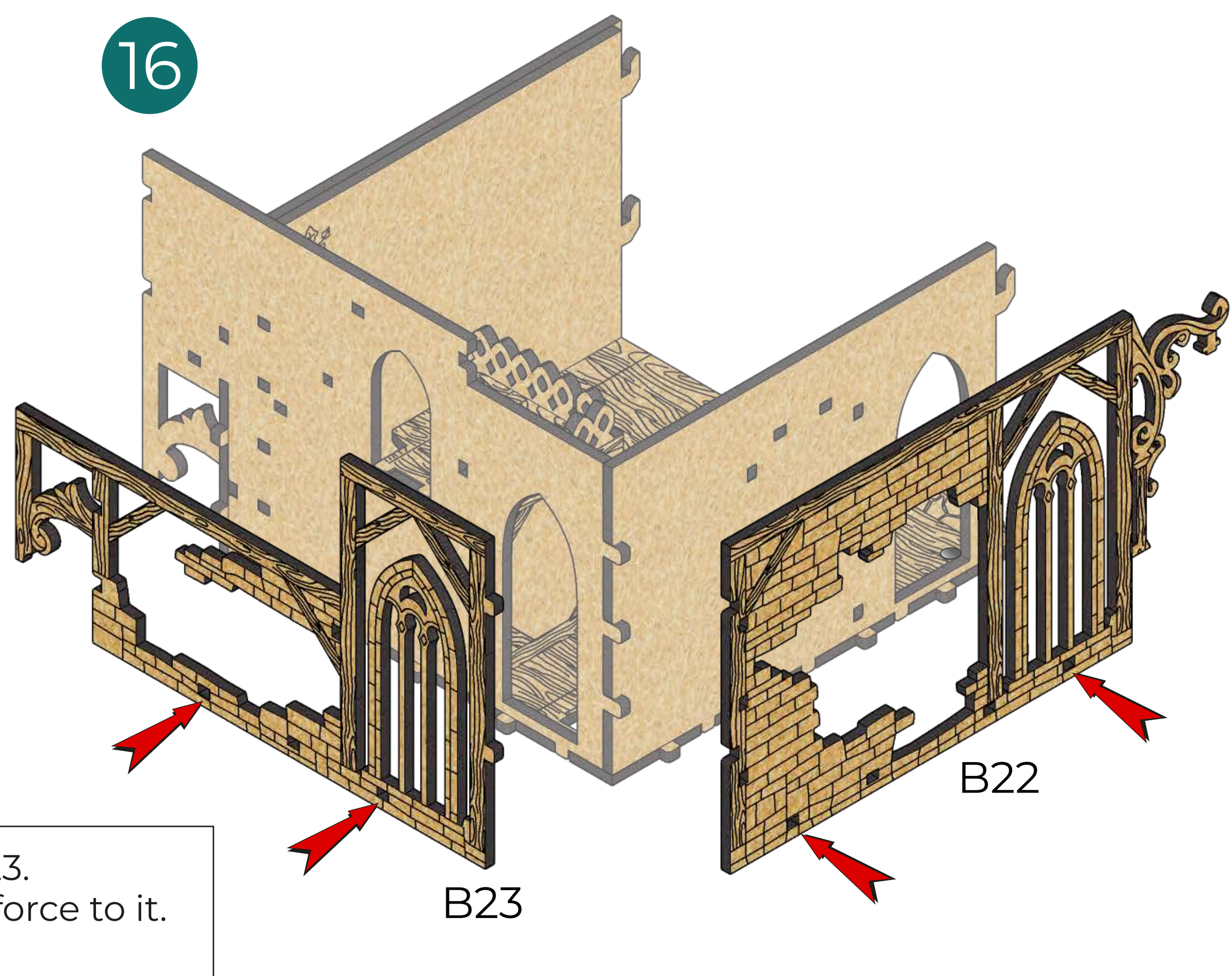

Be careful with part B23.
Don't apply too much force to it.

Будьте обережні з деталлю B23.
Не прикладайте до неї занадто багато сили.

17

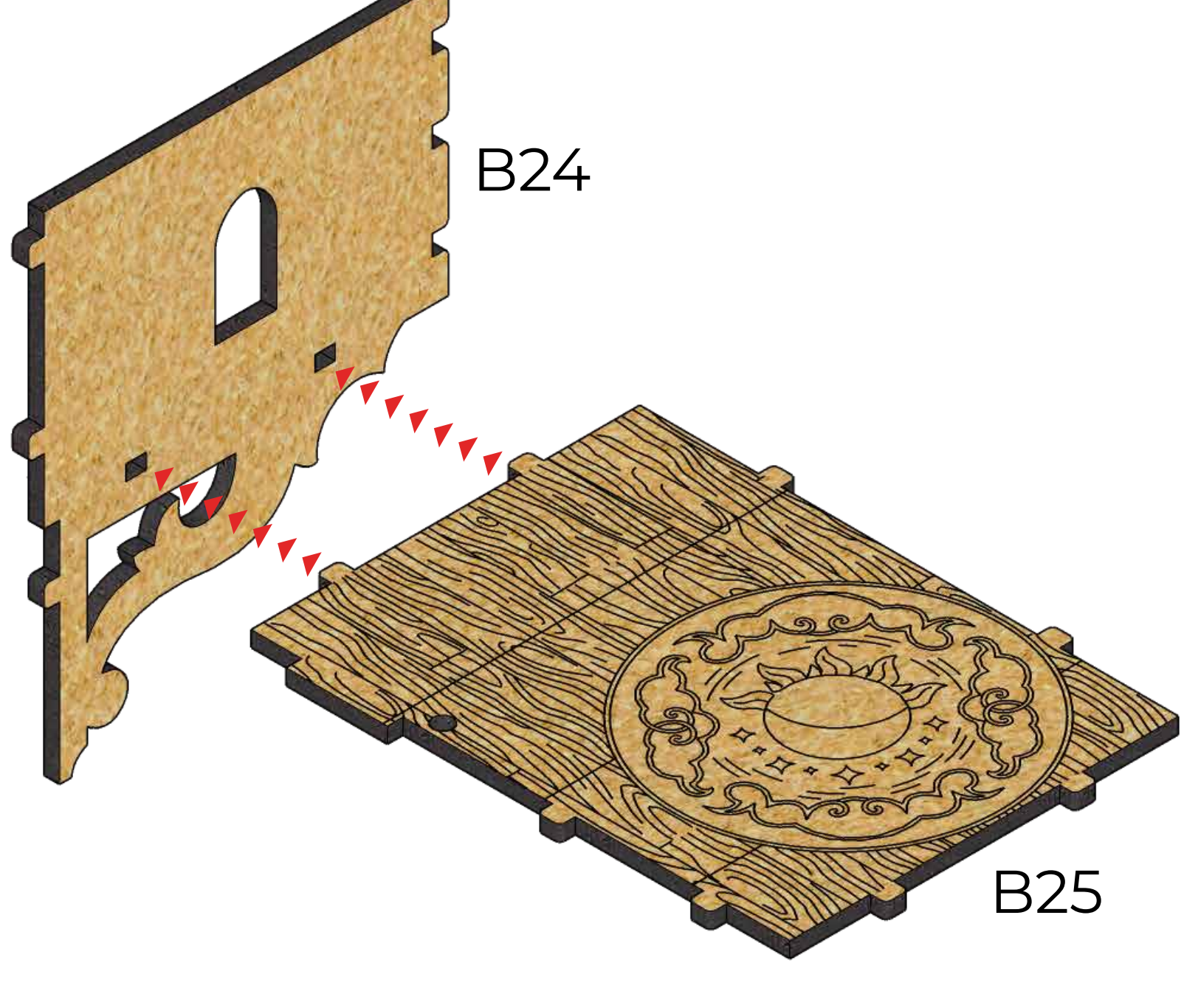

18

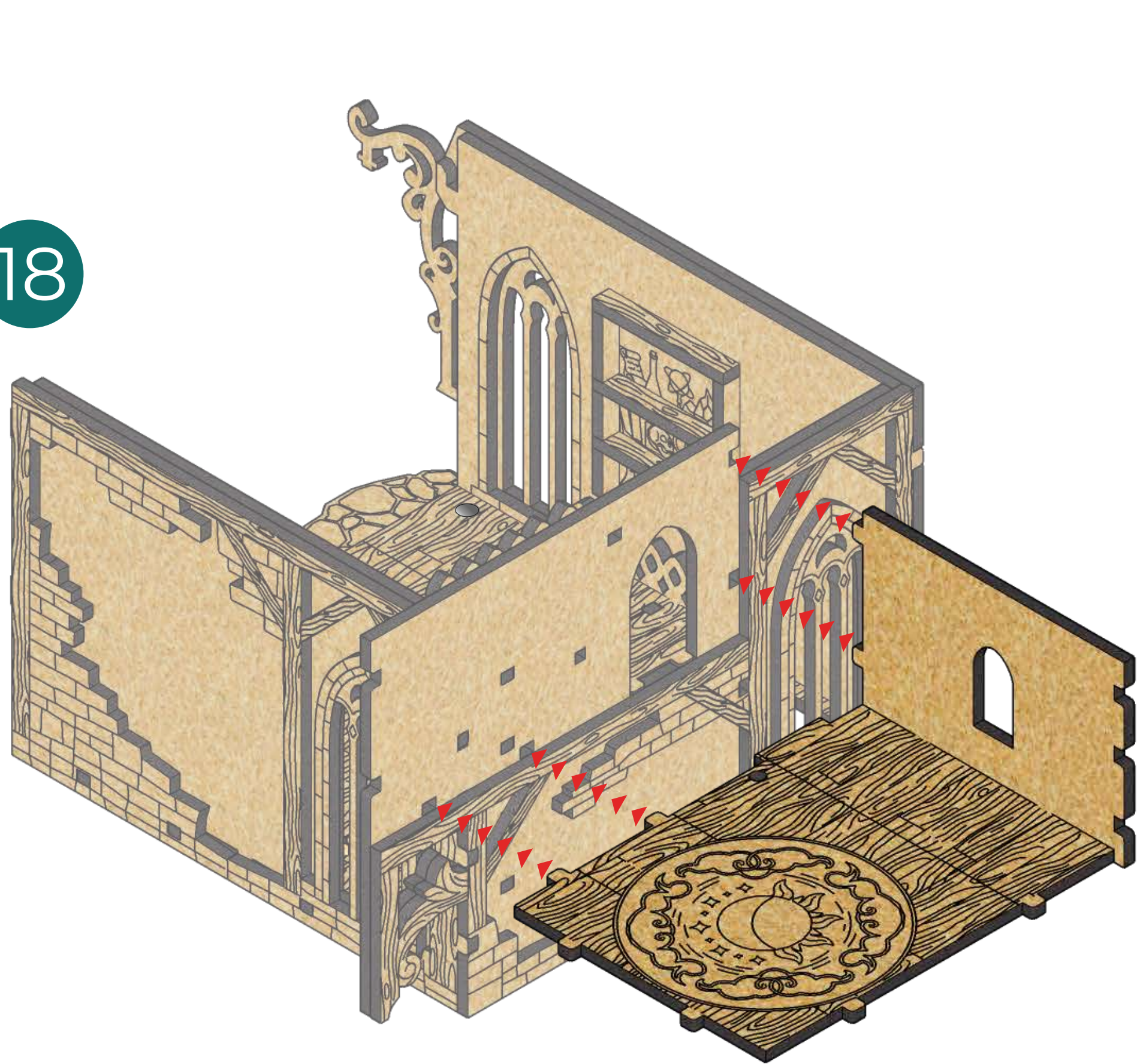

19

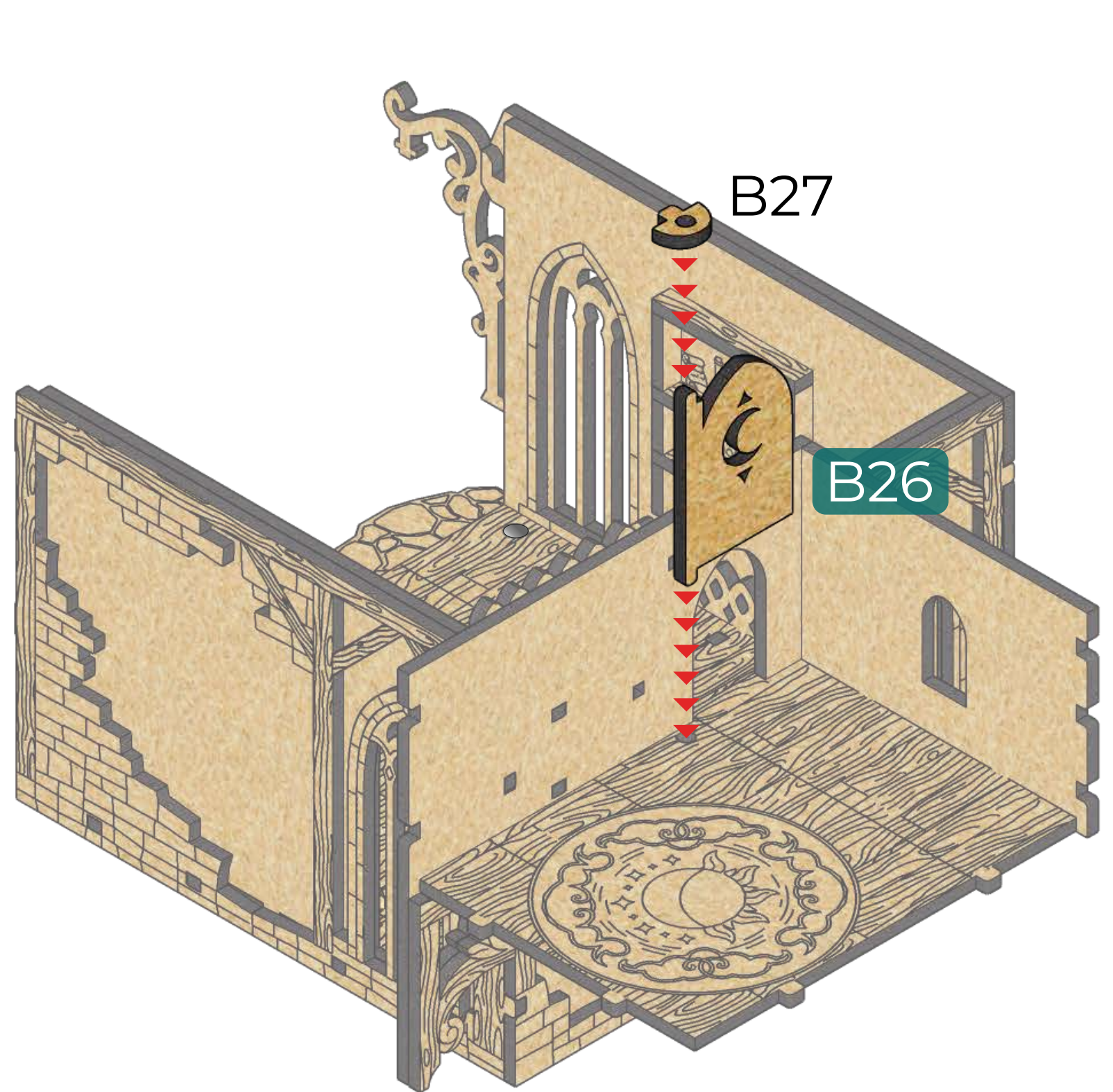

20

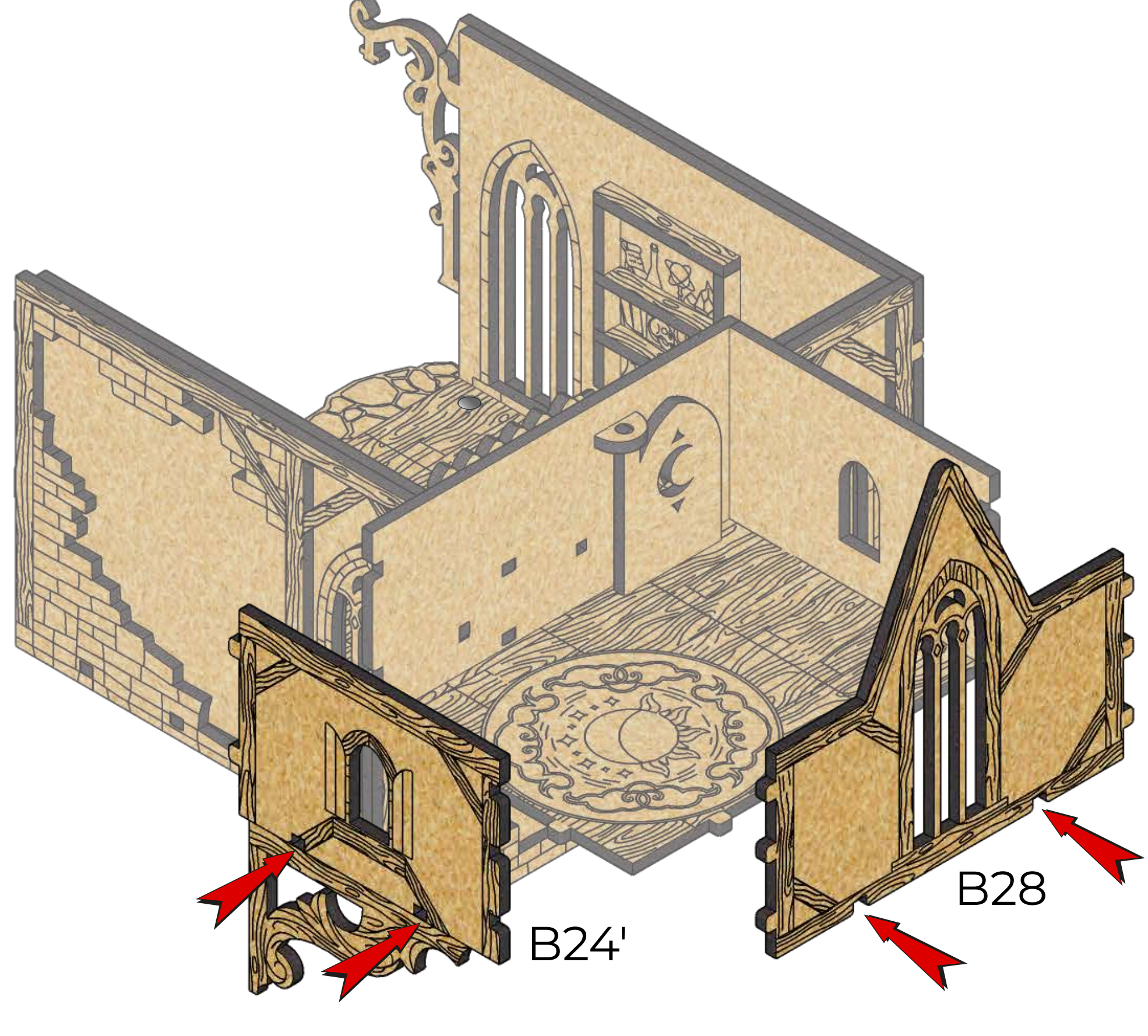

21

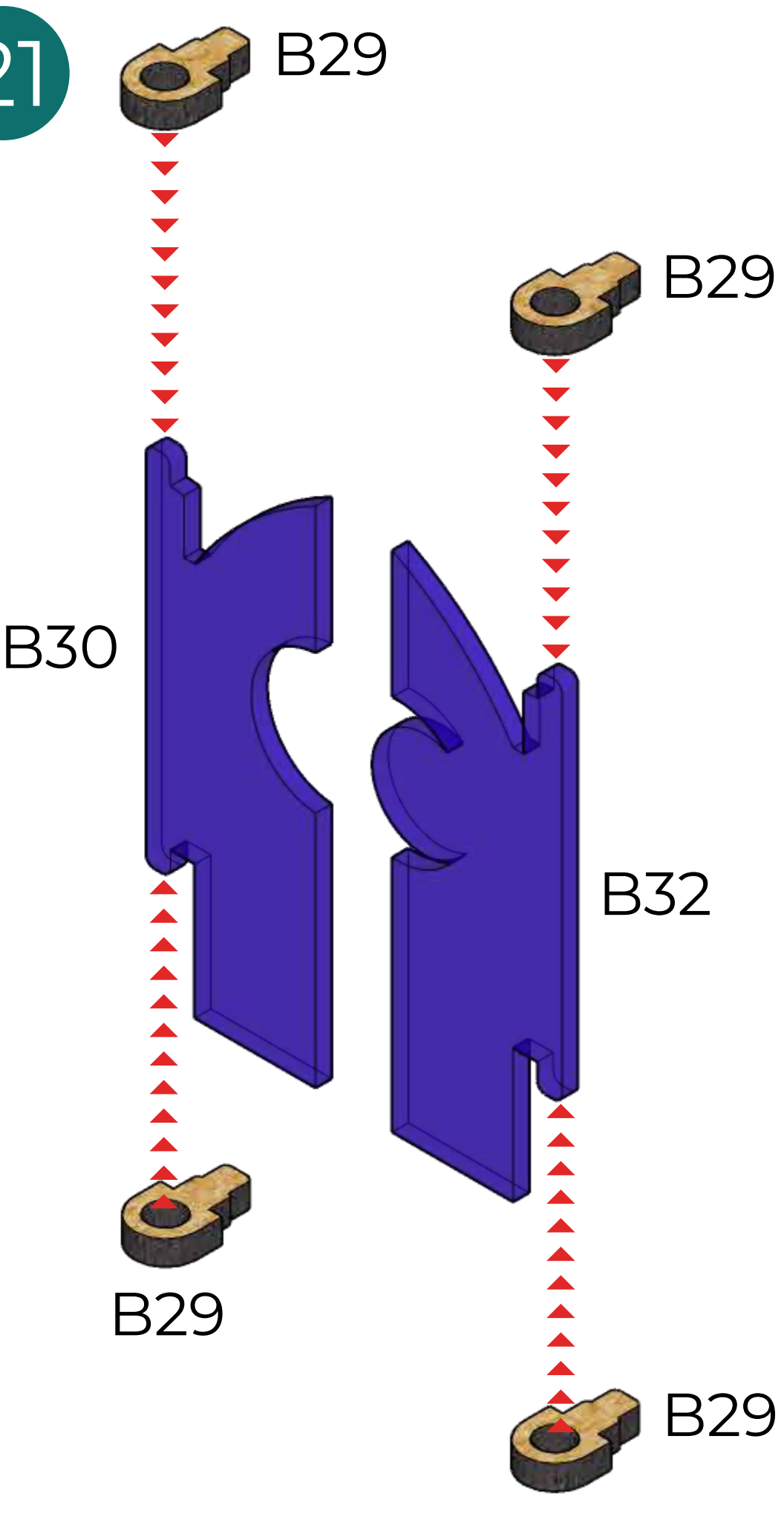

22

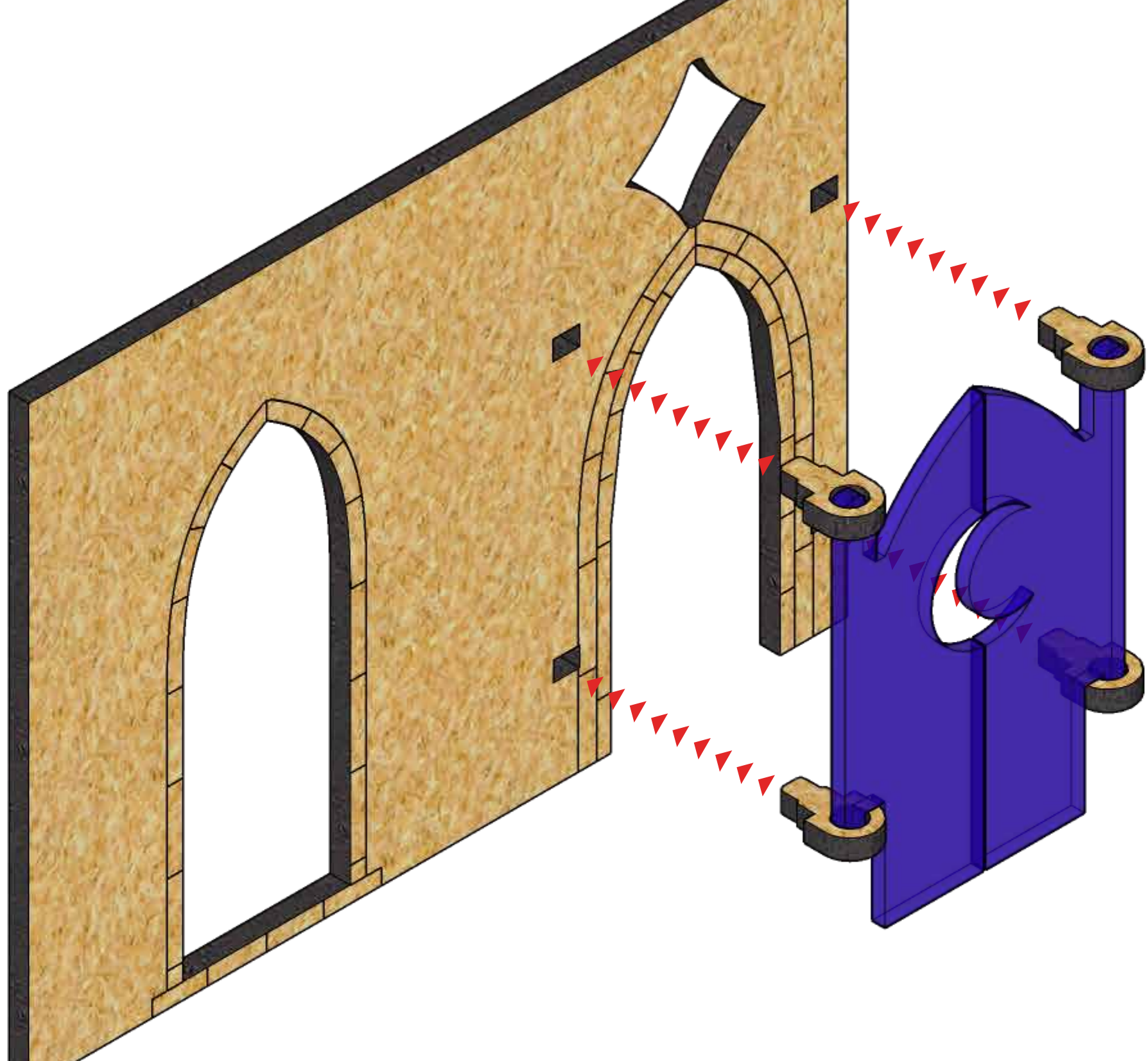

23

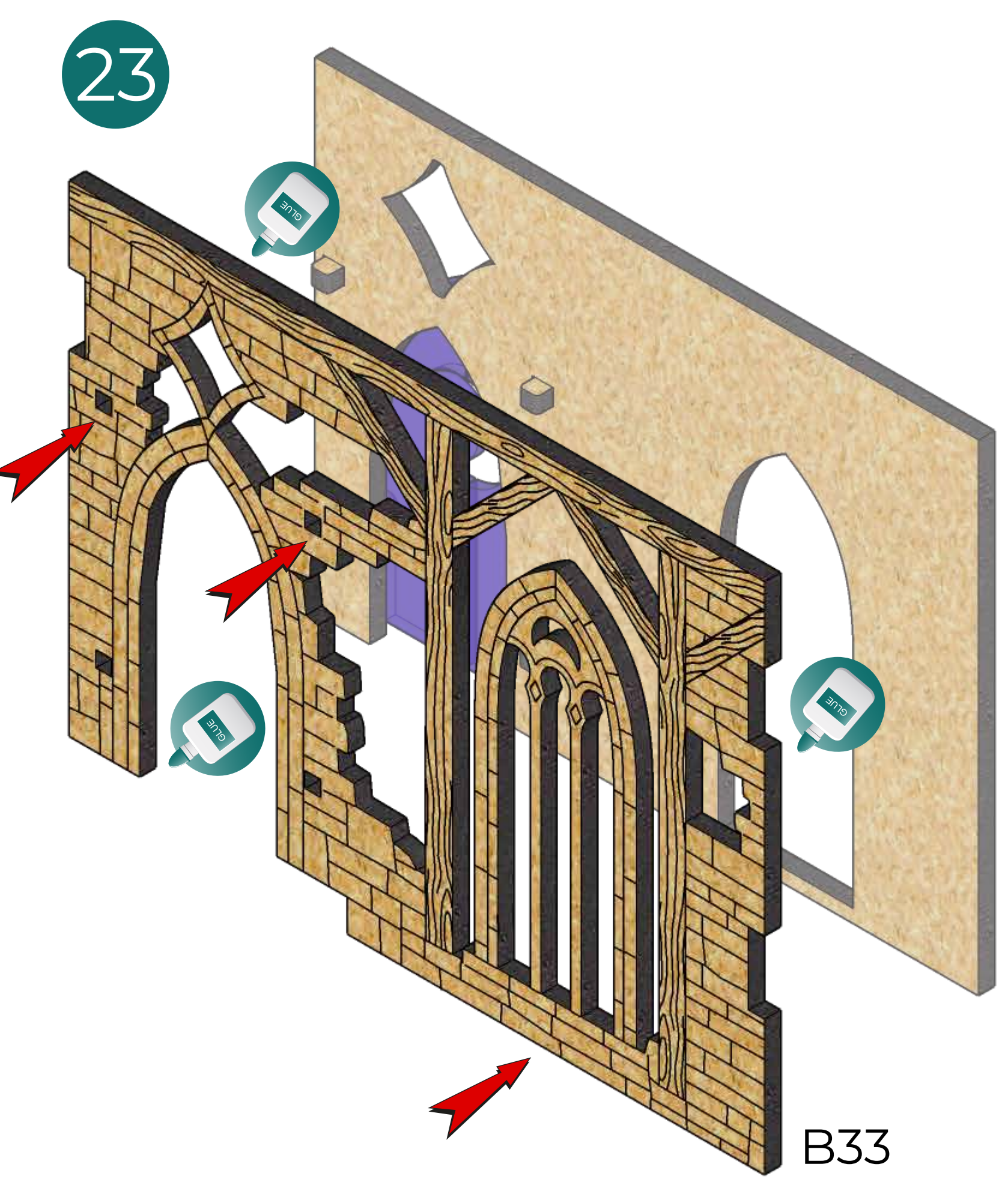

24

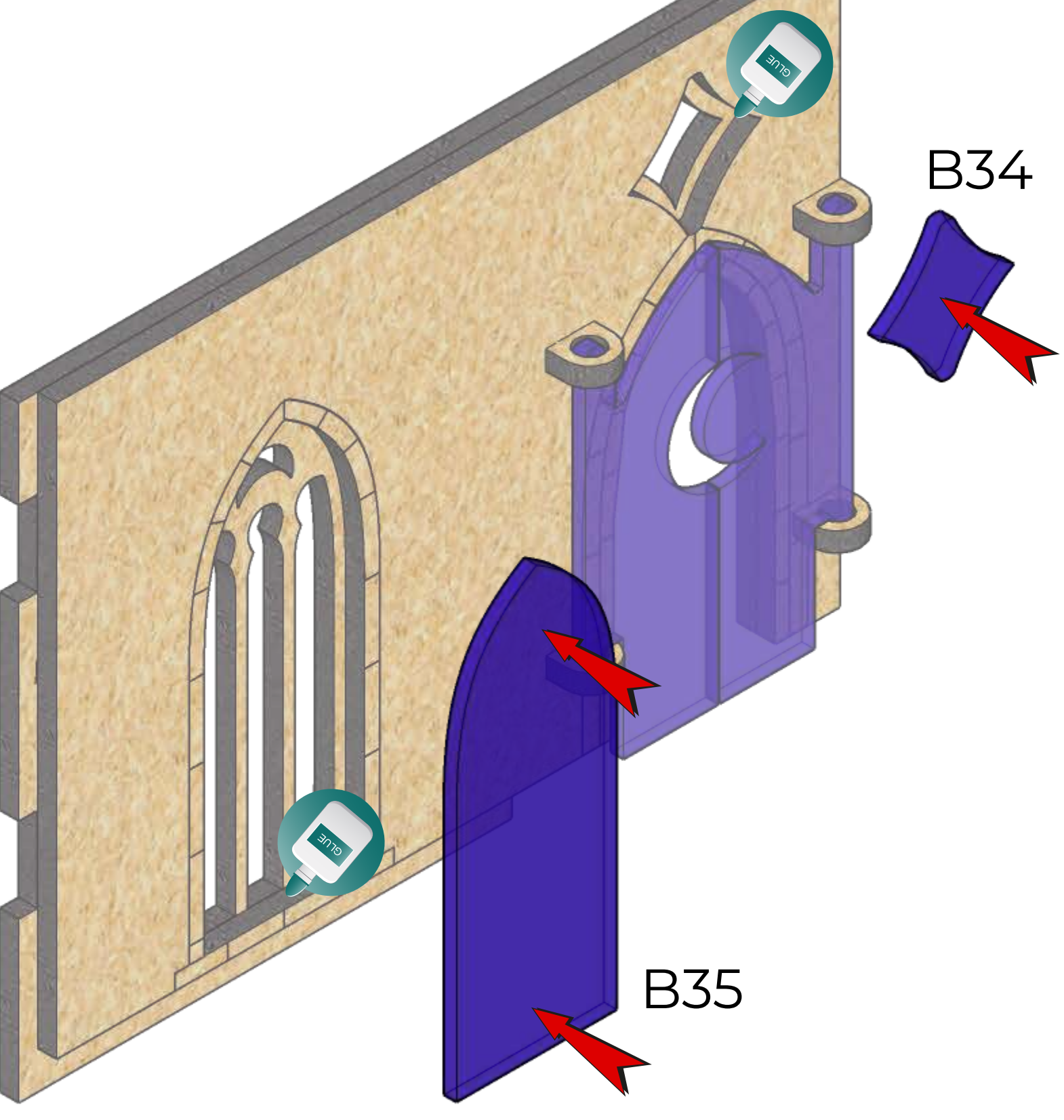

25

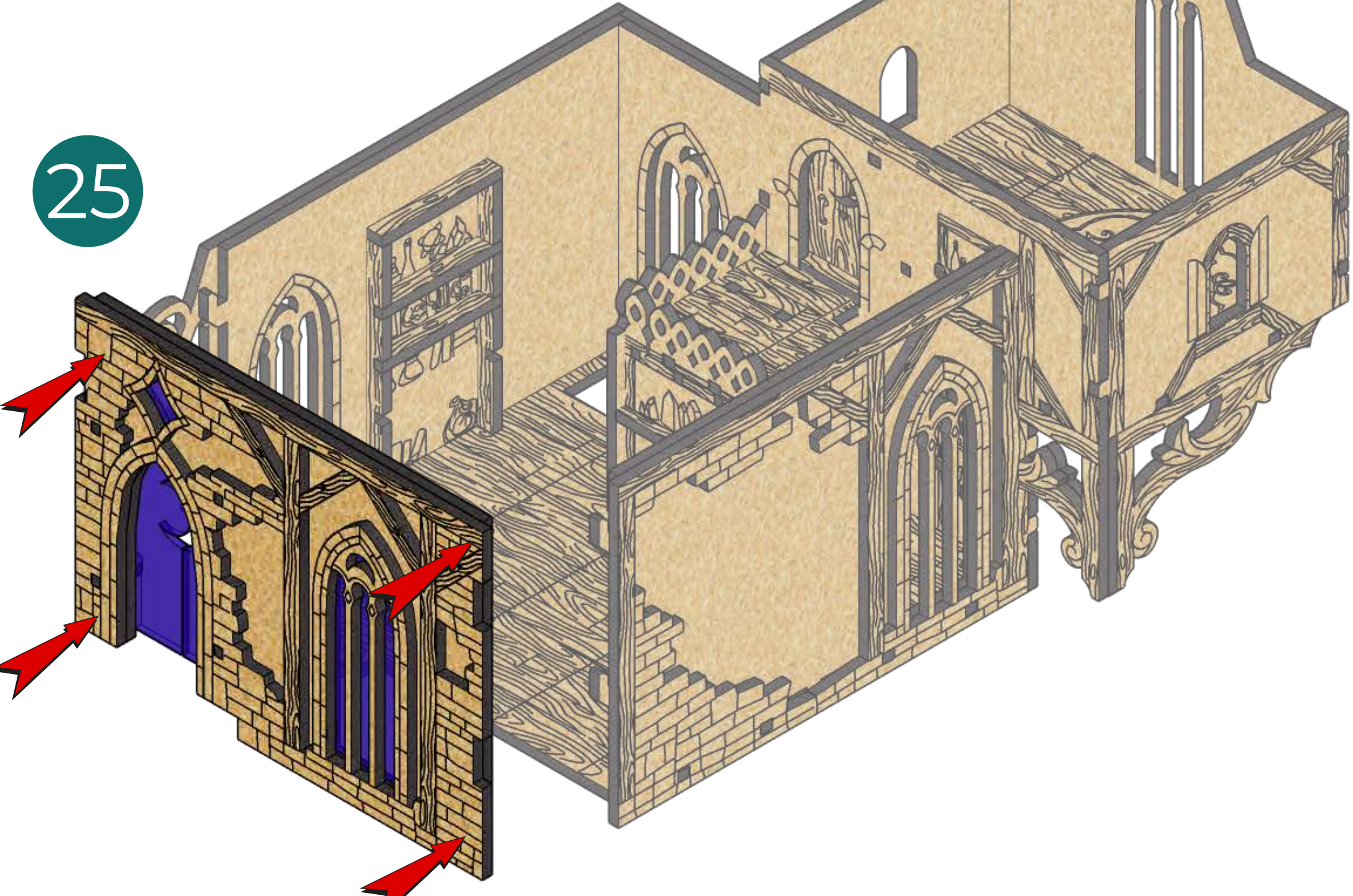

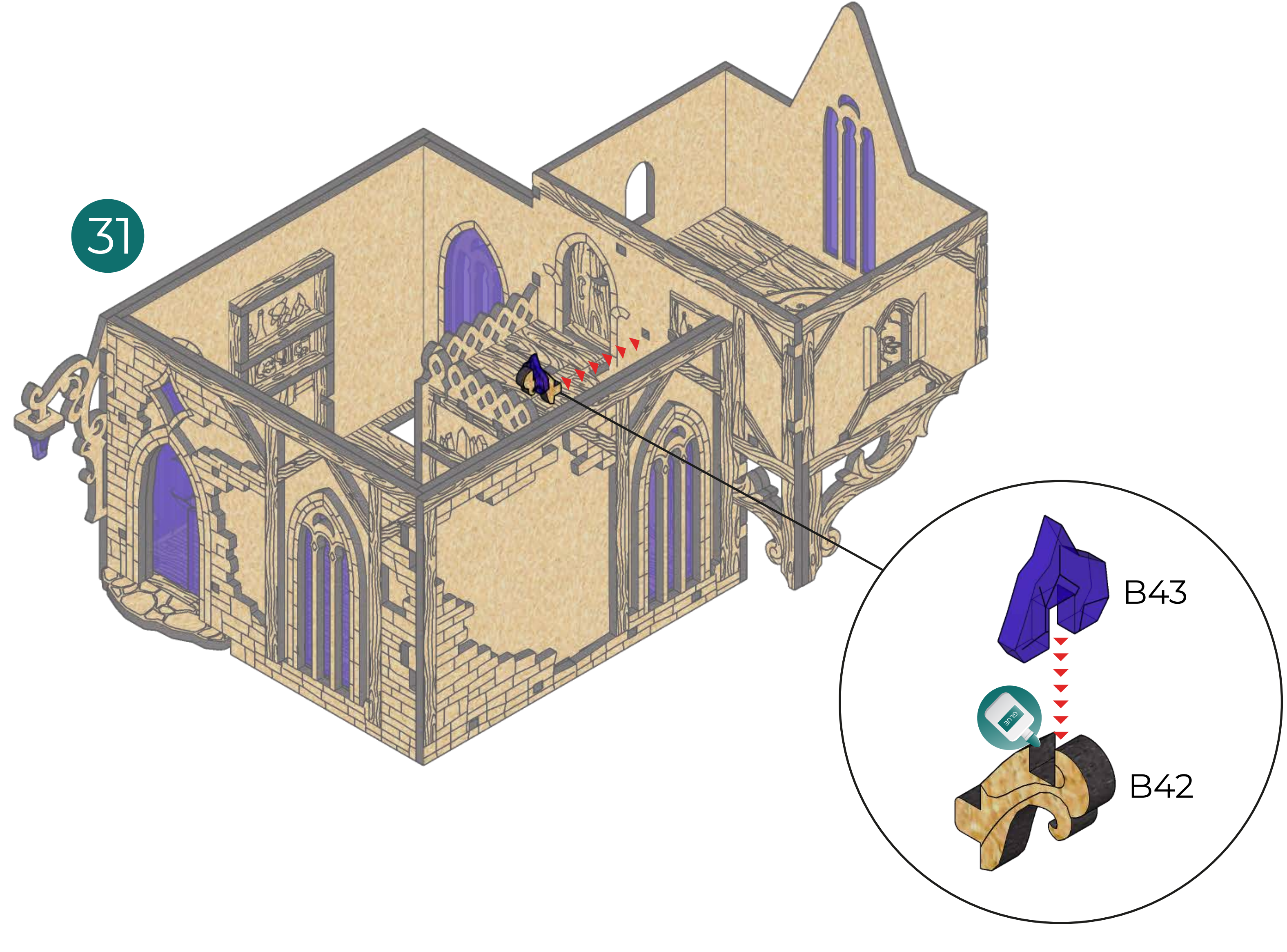
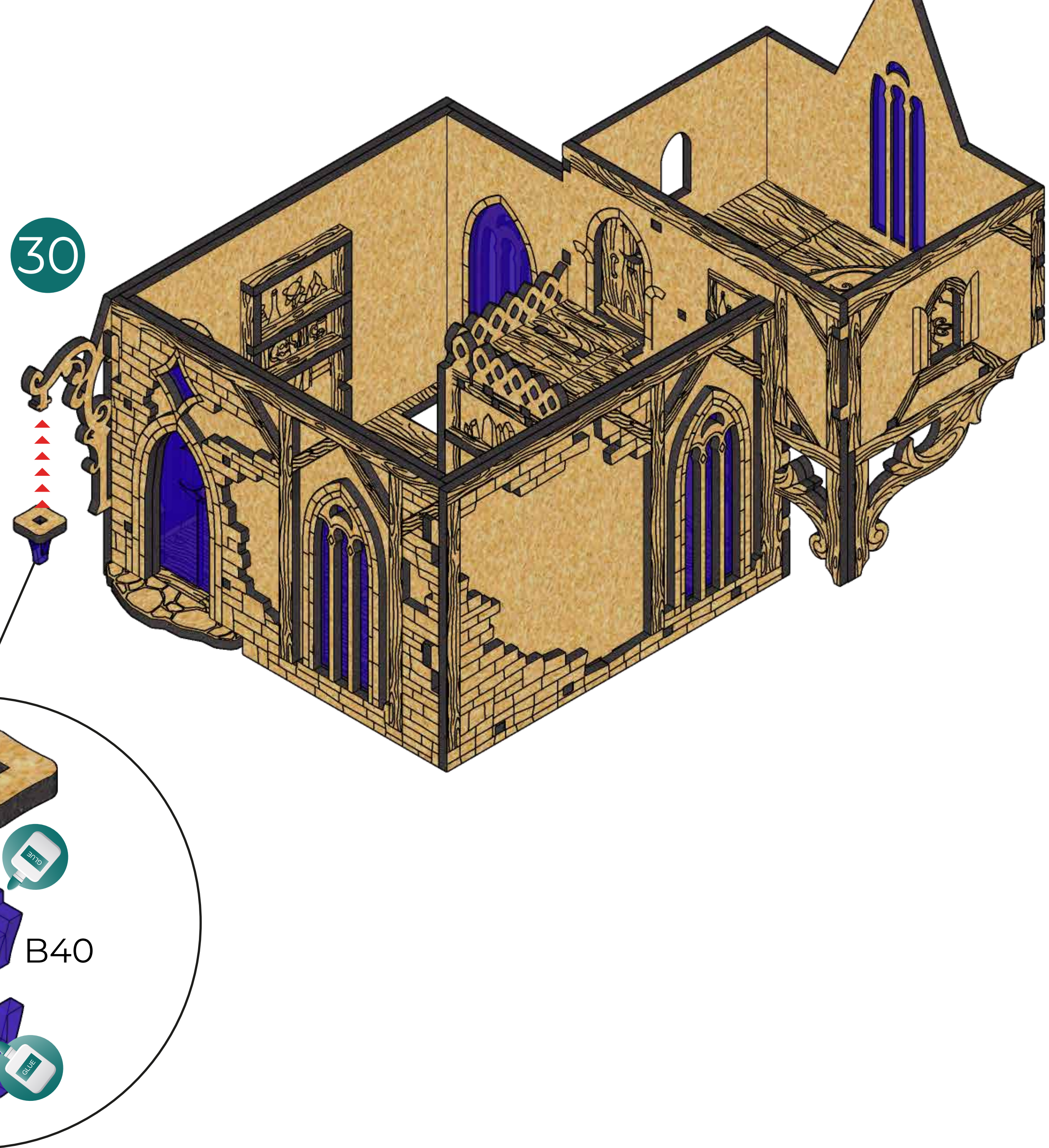
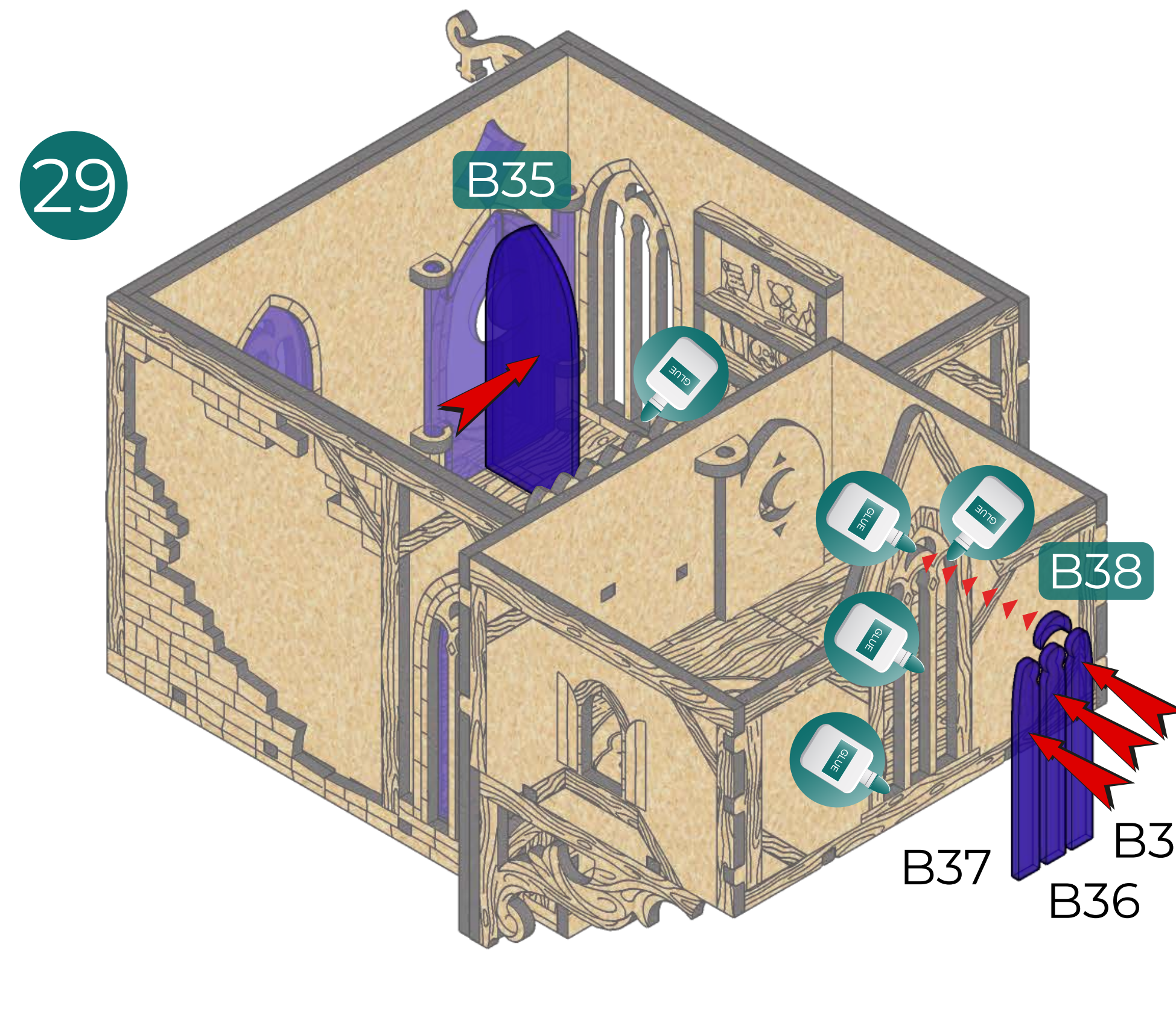
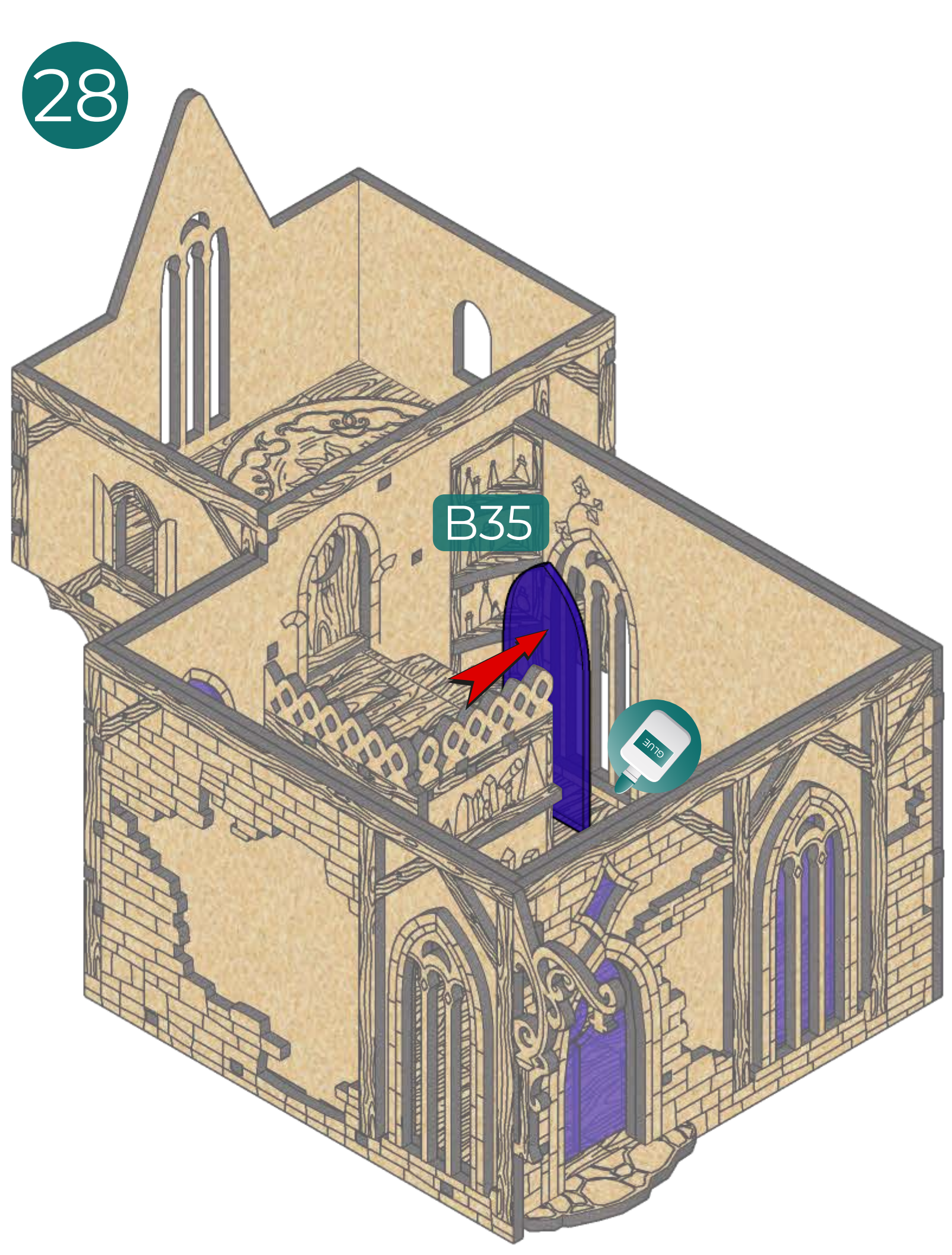
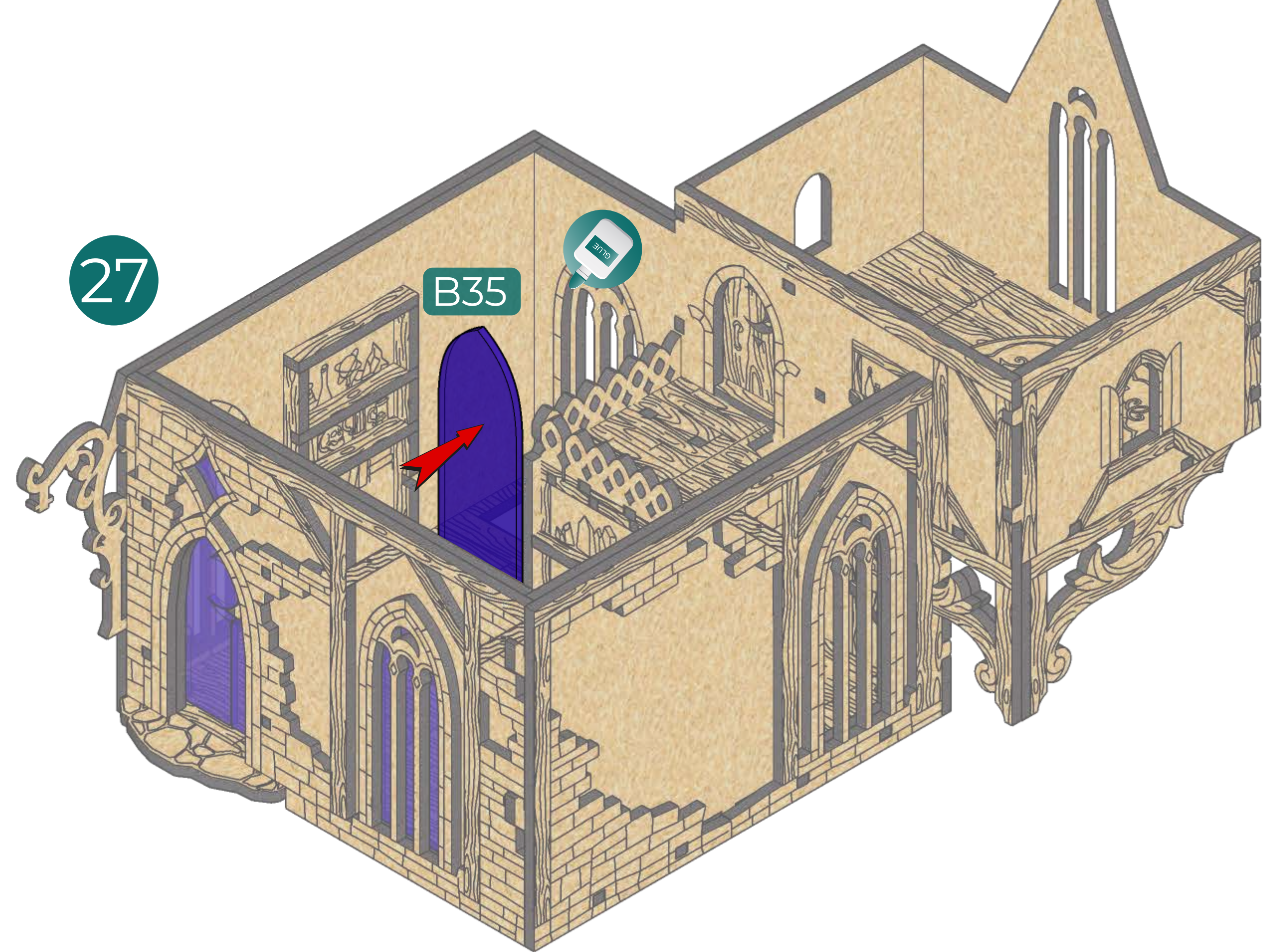
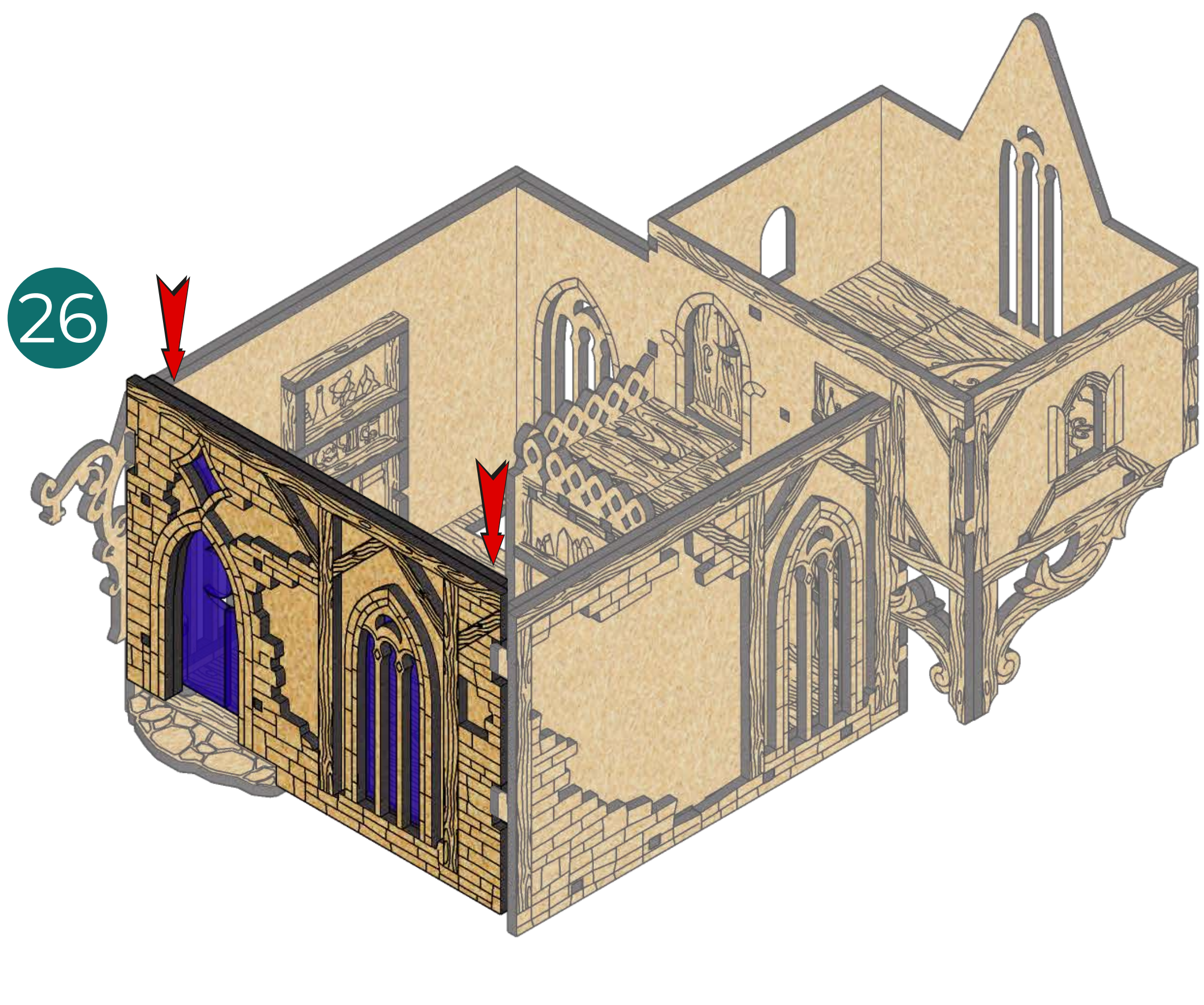

C

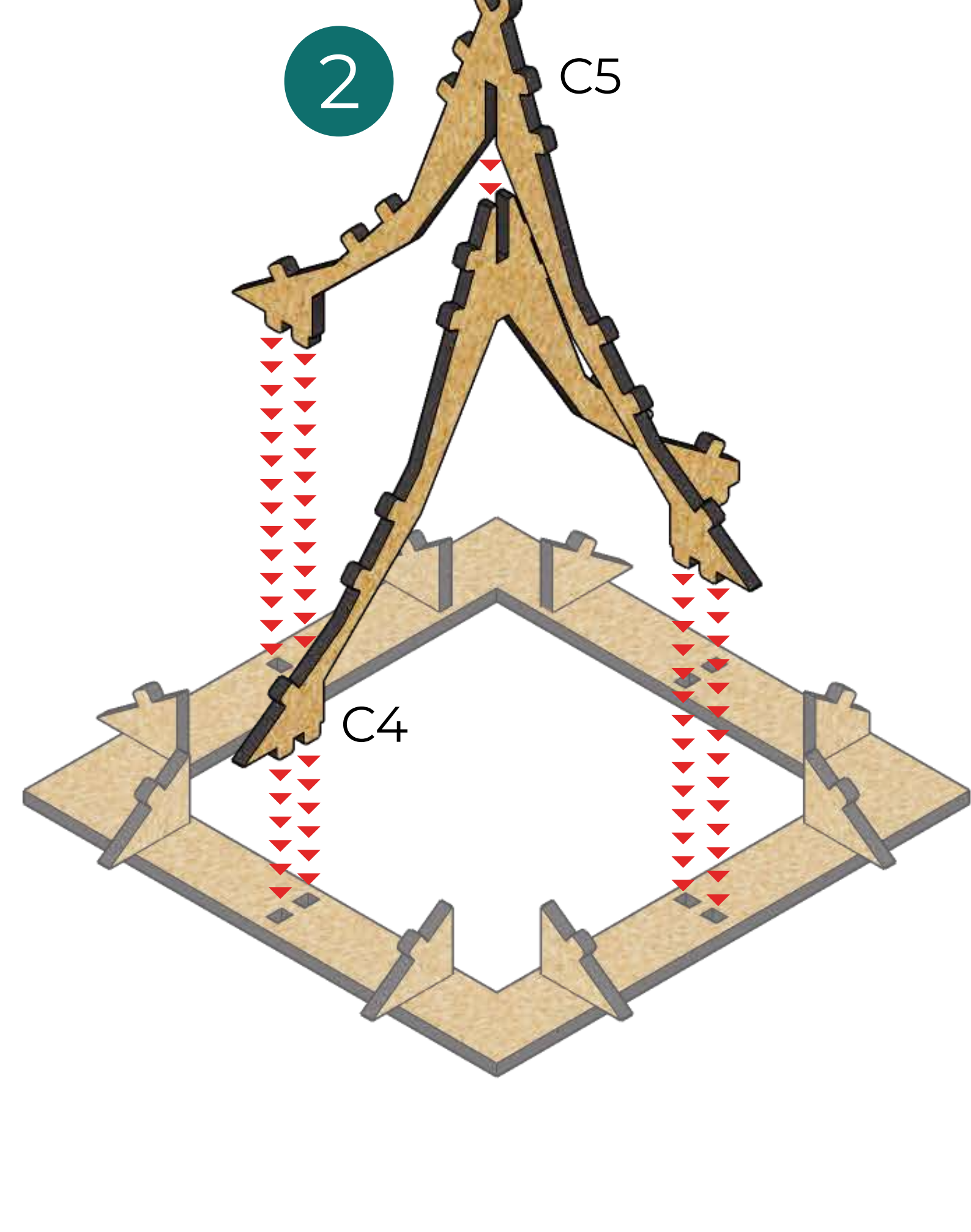
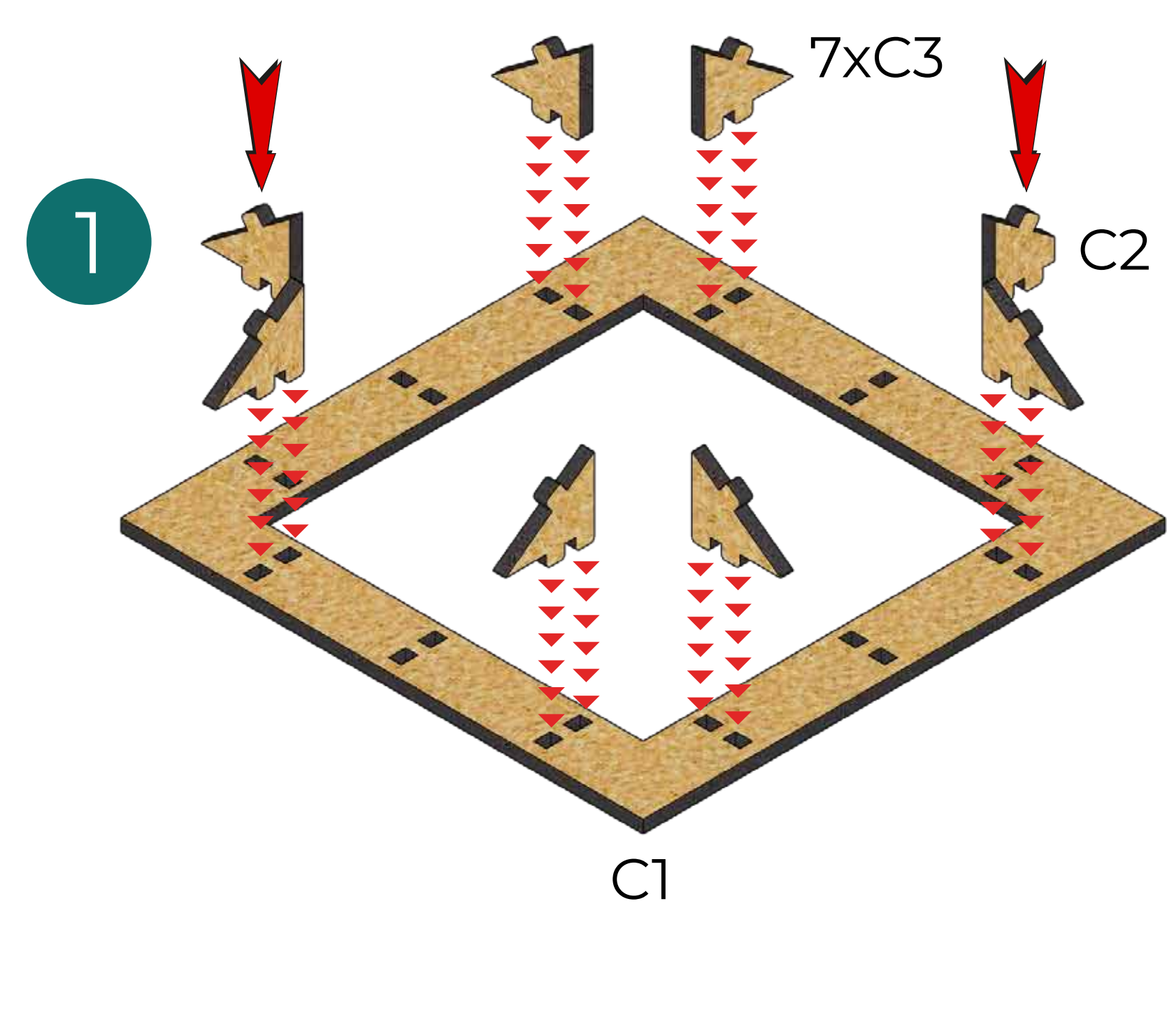

Be careful with parts C4, C5.
Don't apply too much force to them.

Будьте обережні з деталями C4, C5.
Не прикладайте до них занадто багато сили.

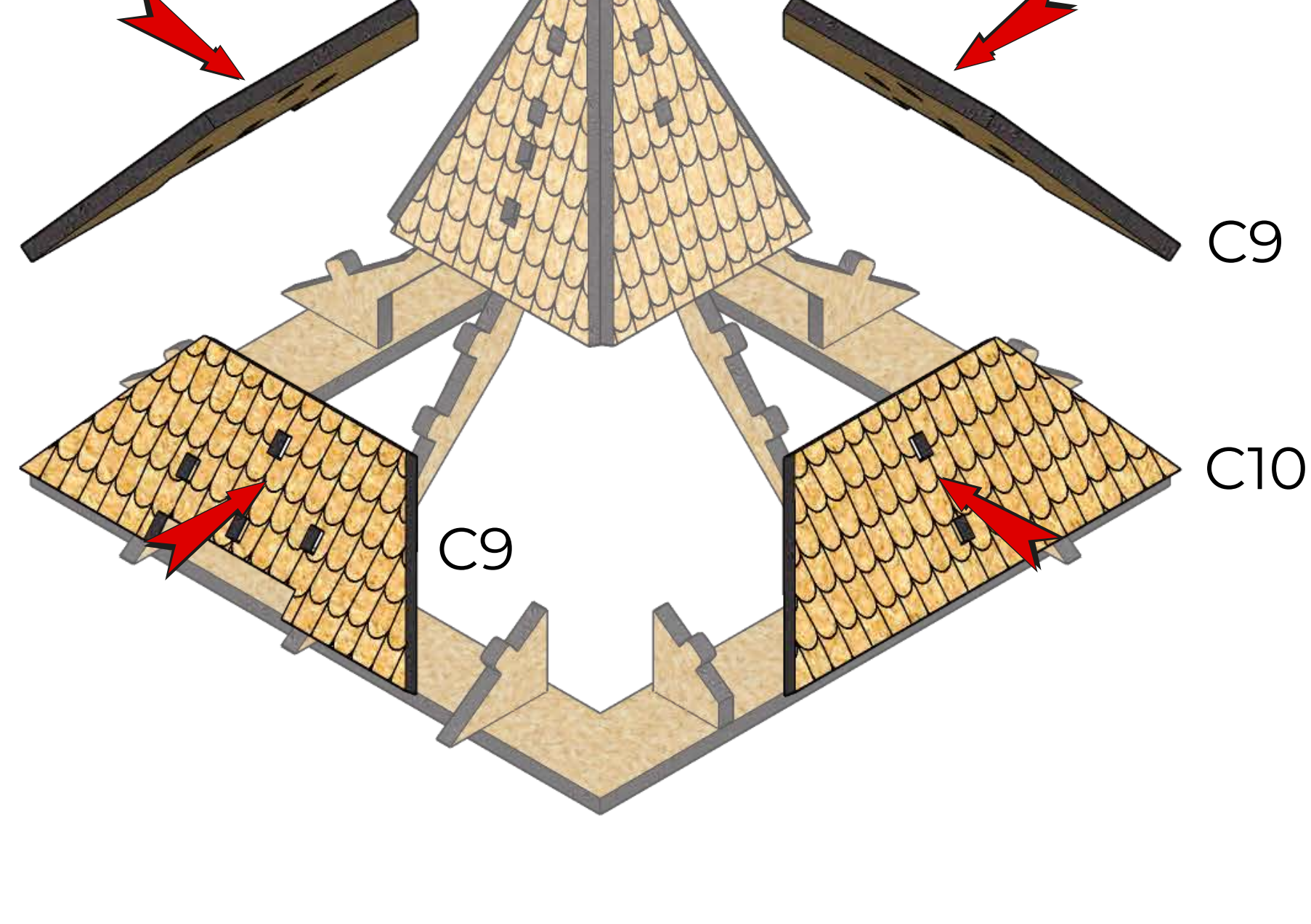
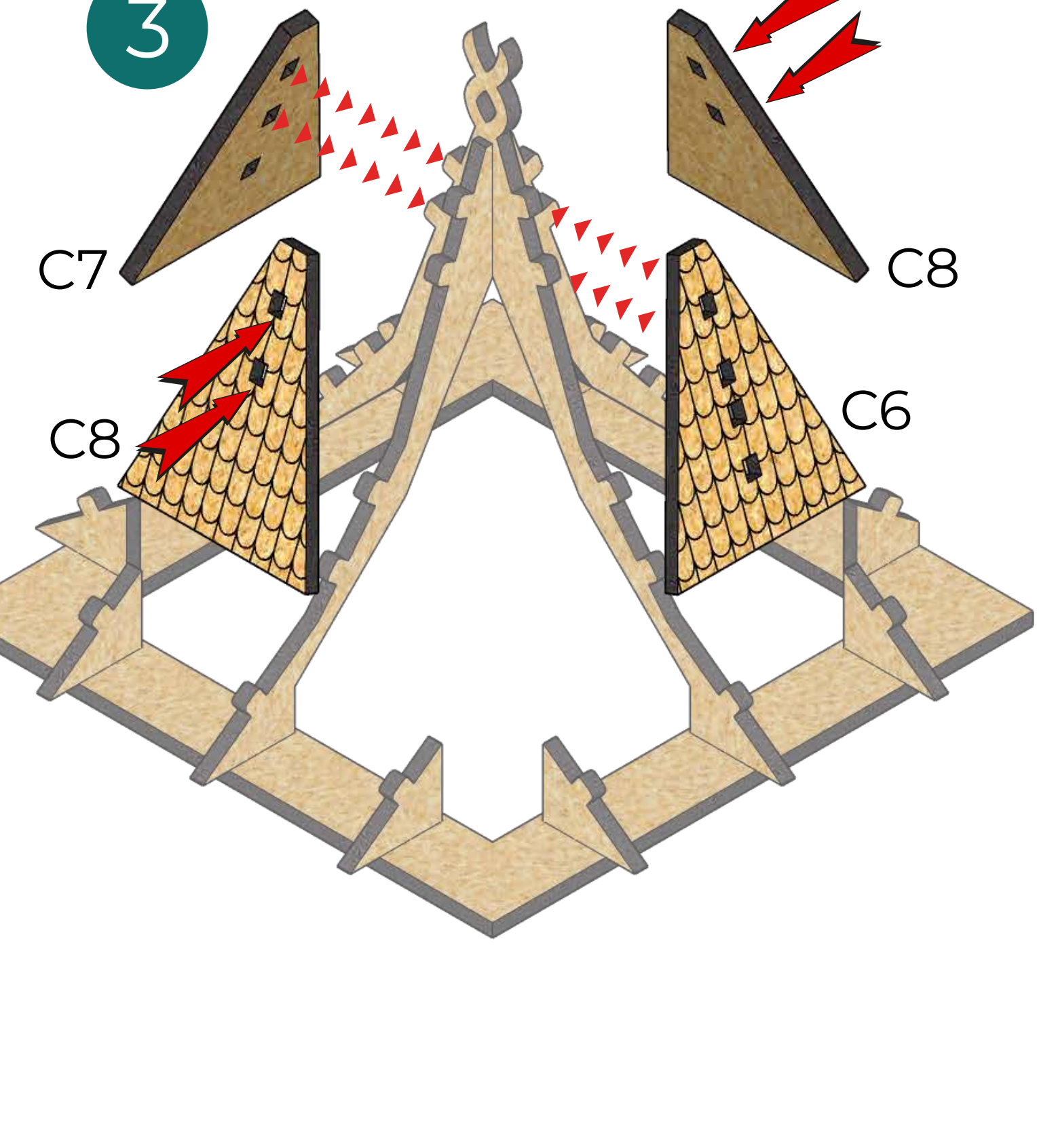

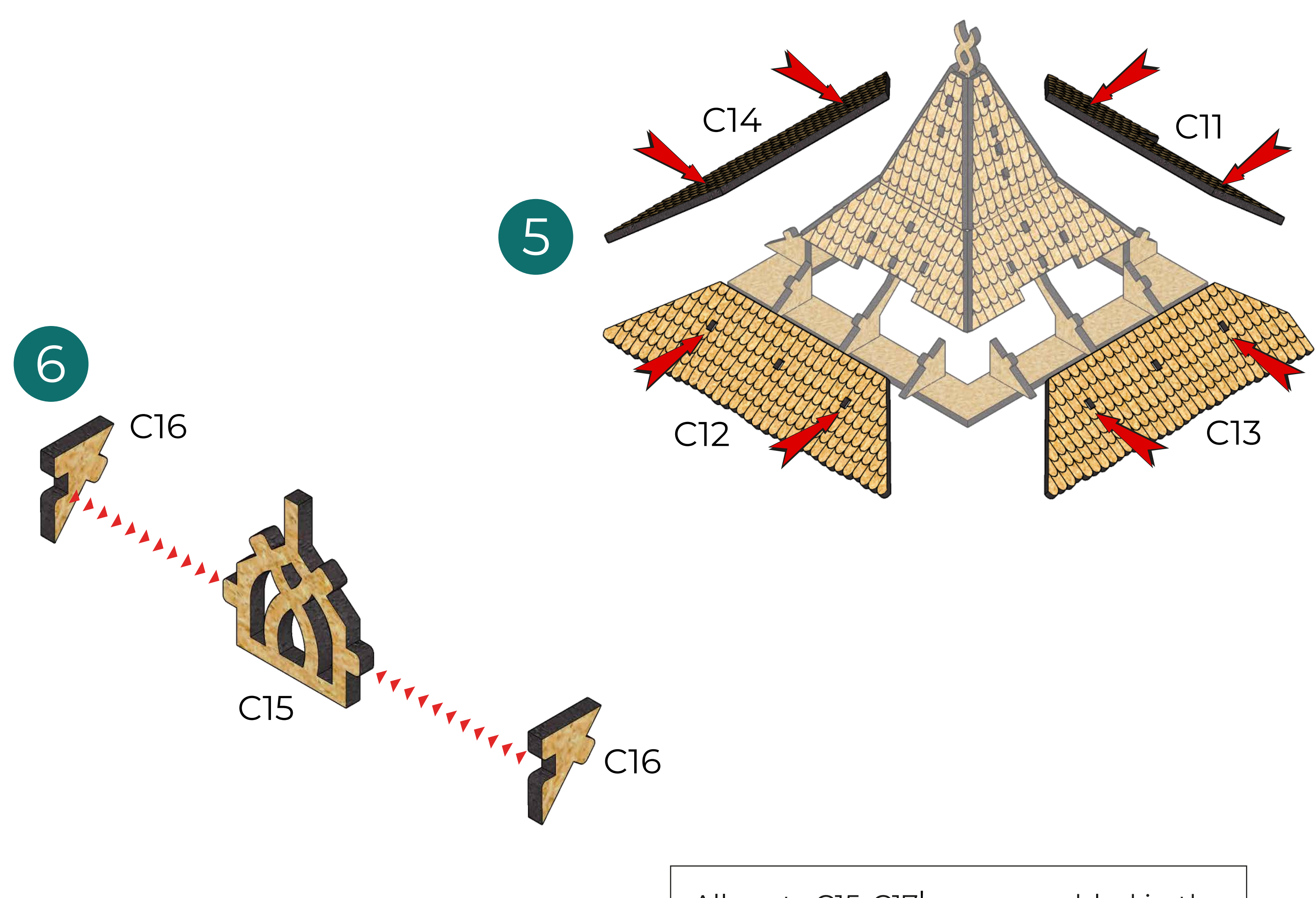

All parts C15-C17' are assembled in the same way.
Всі деталі C15-C17' складаються аналогічно.

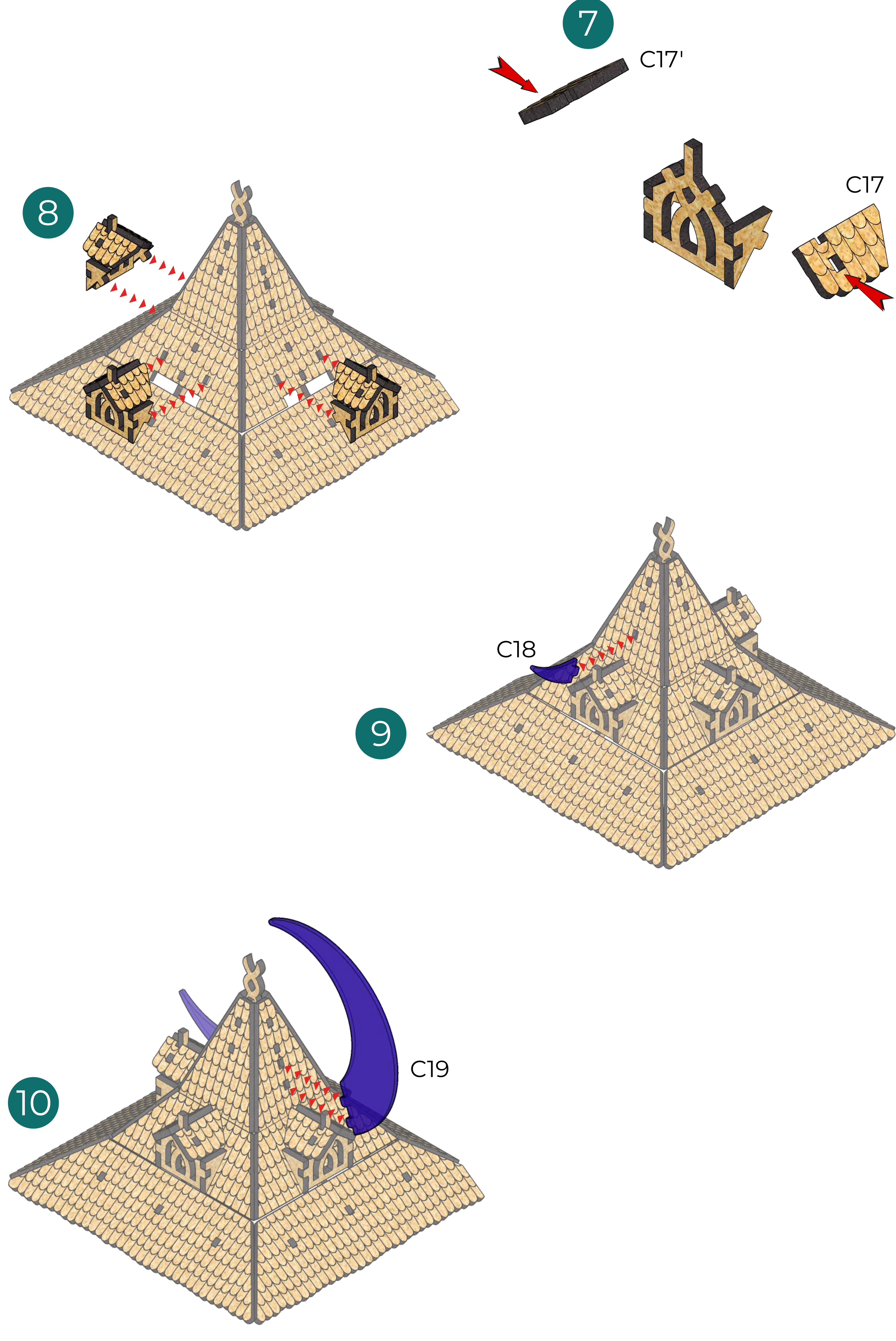

D



E

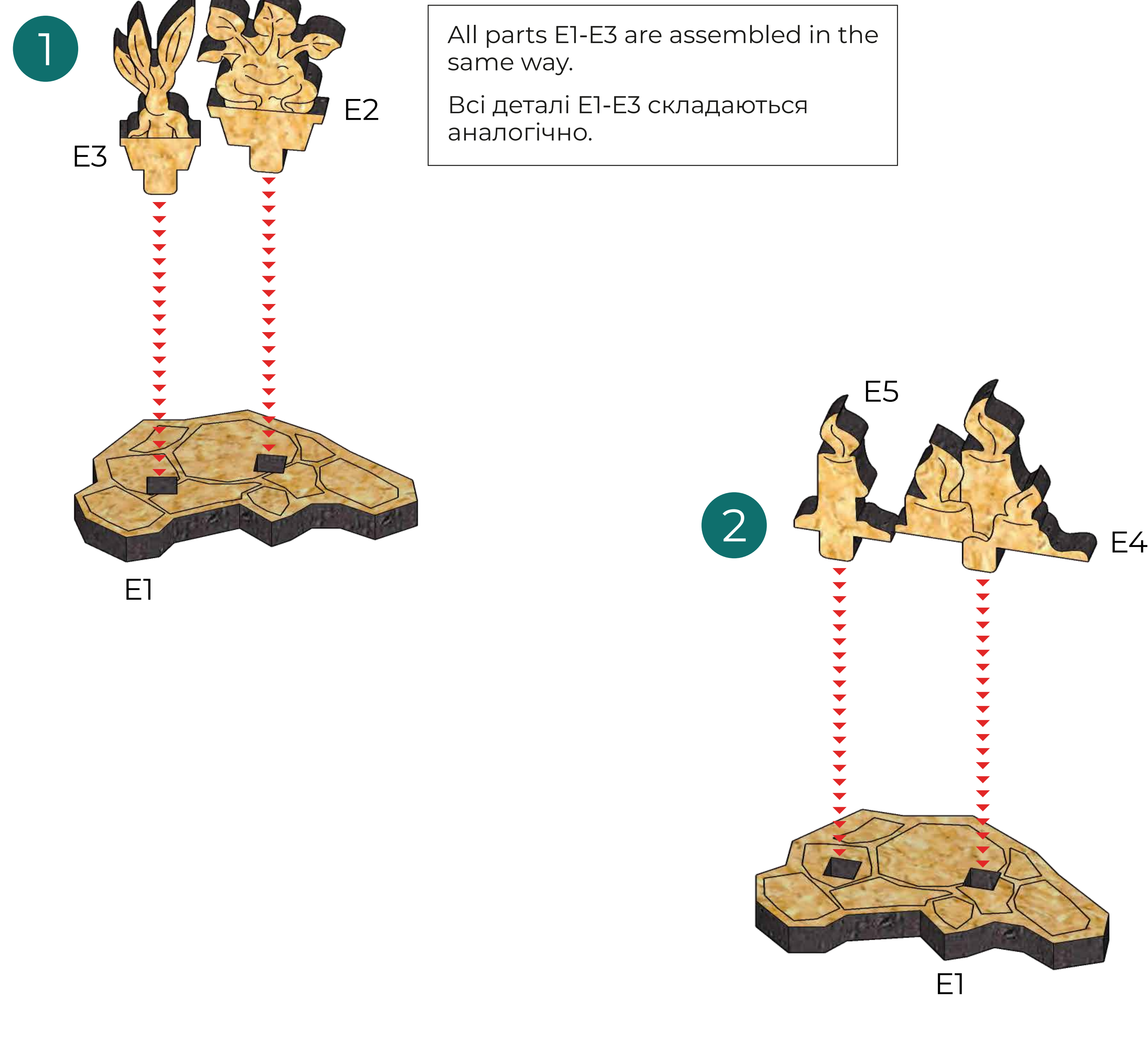

All parts E1-E3 are assembled in the same way.
Всі деталі E1-E3 складаються аналогічно.

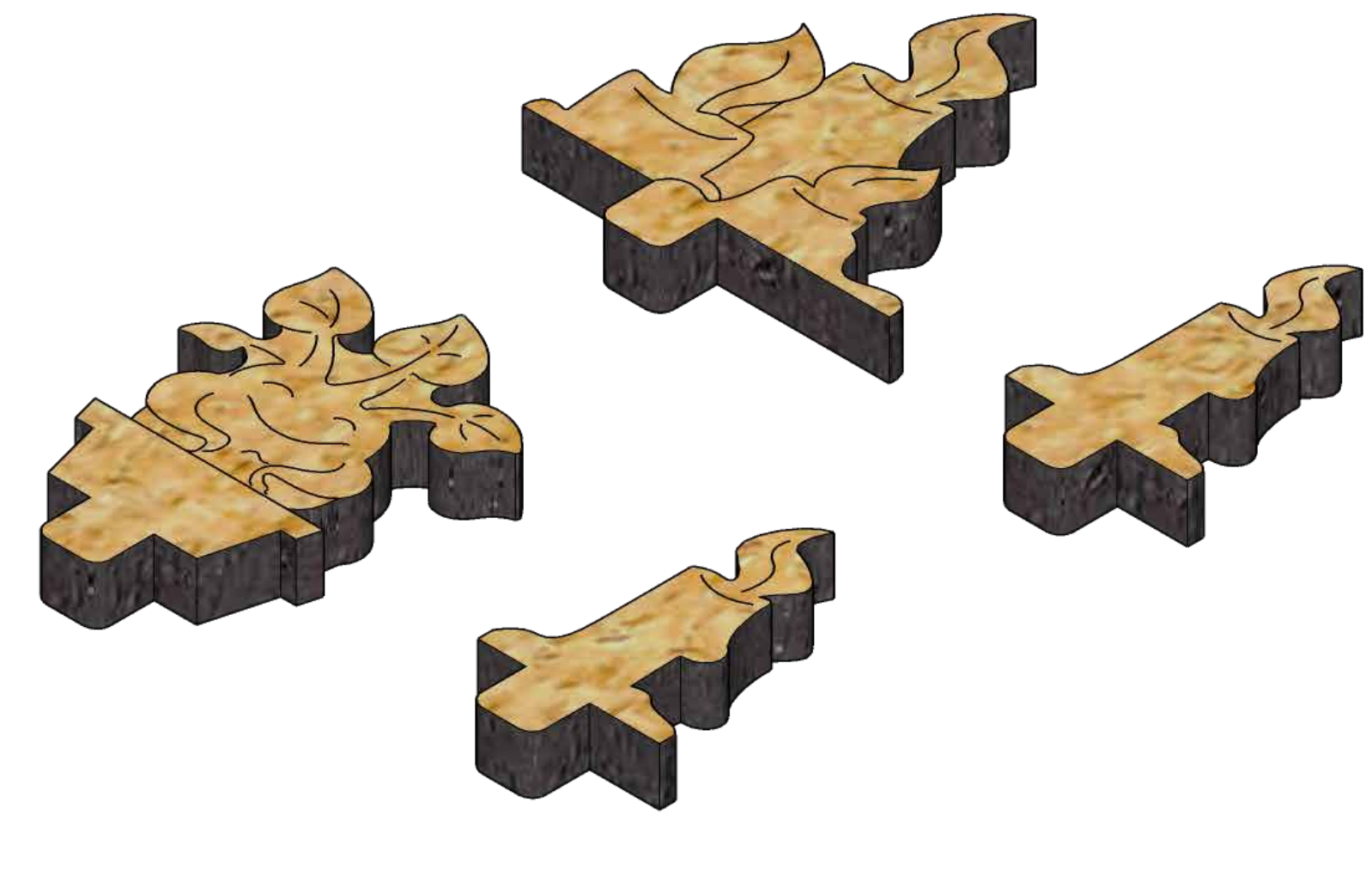

4 spare parts: 2xE5, E4 and E2.
4 запасні деталі: 2xE5, E4 і E2.

F

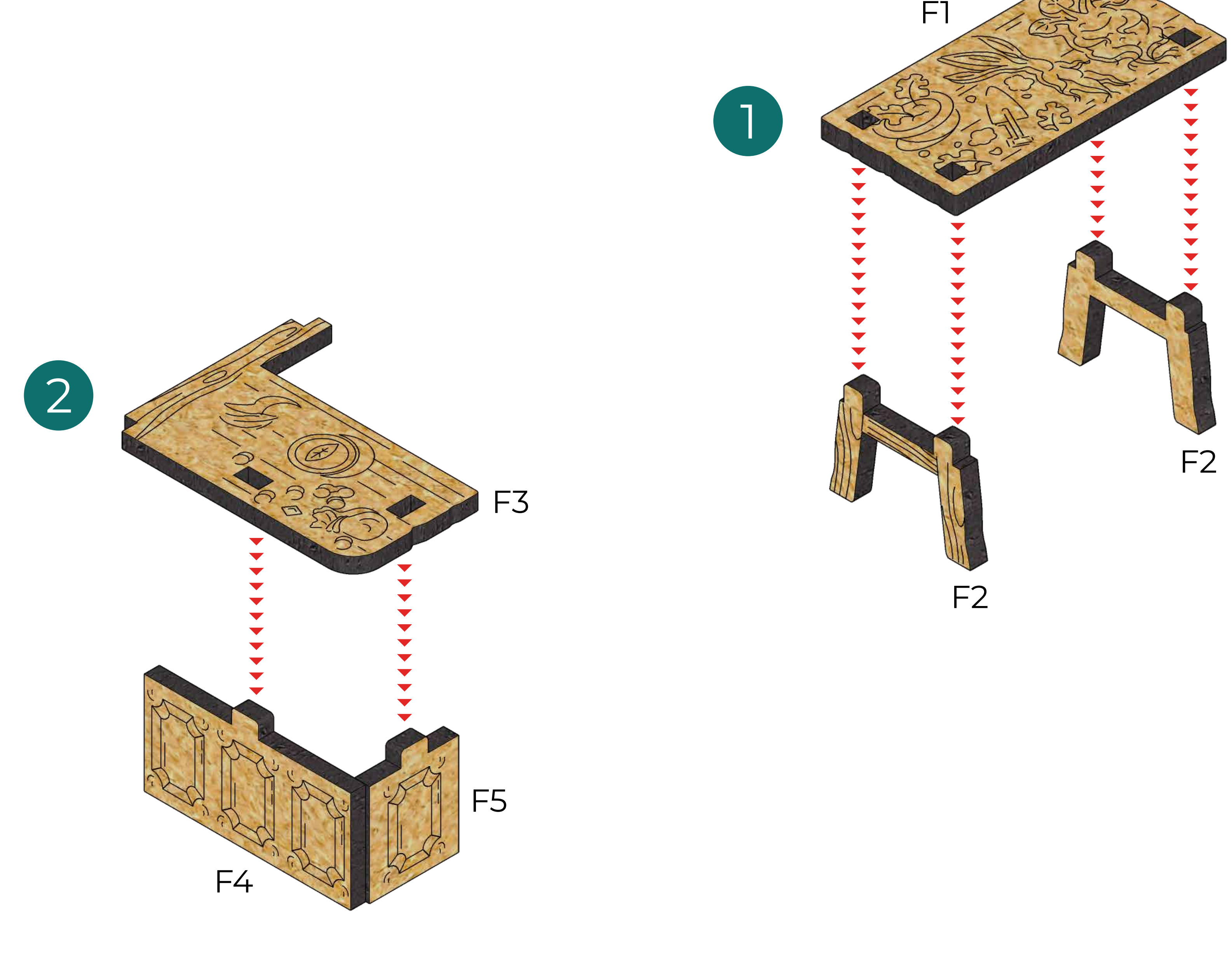

G

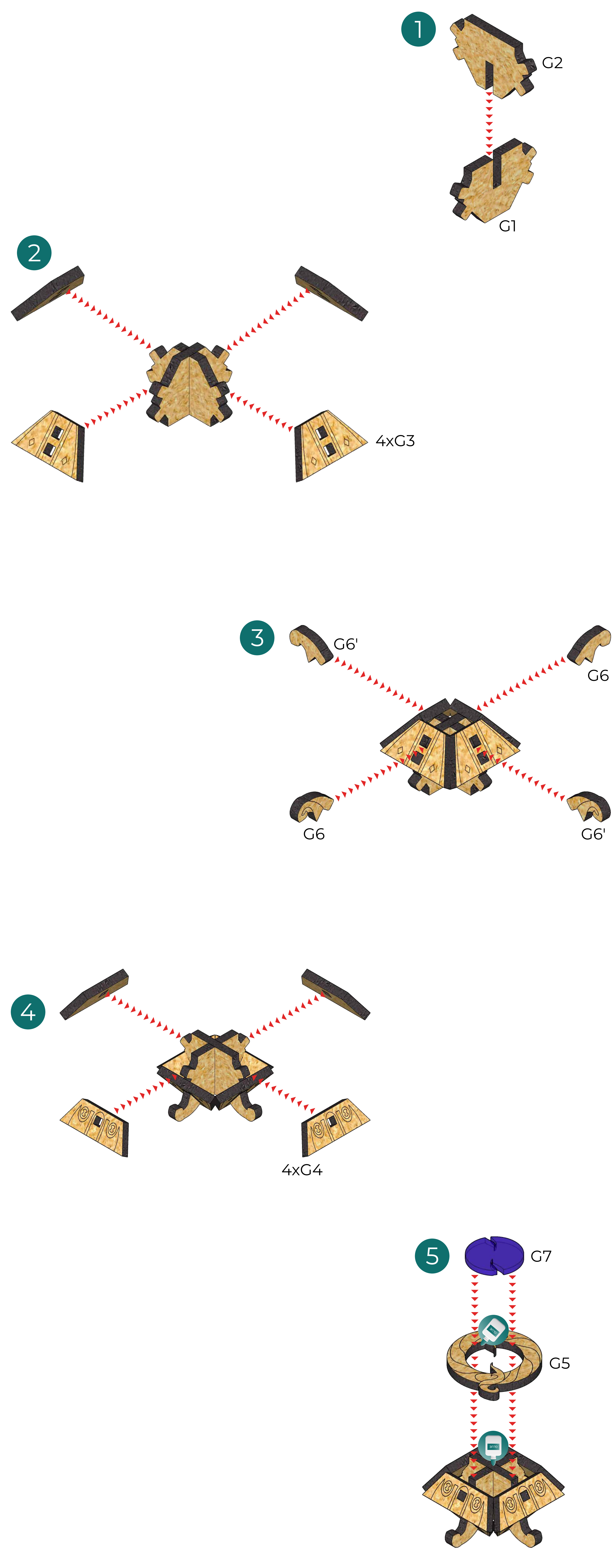

H

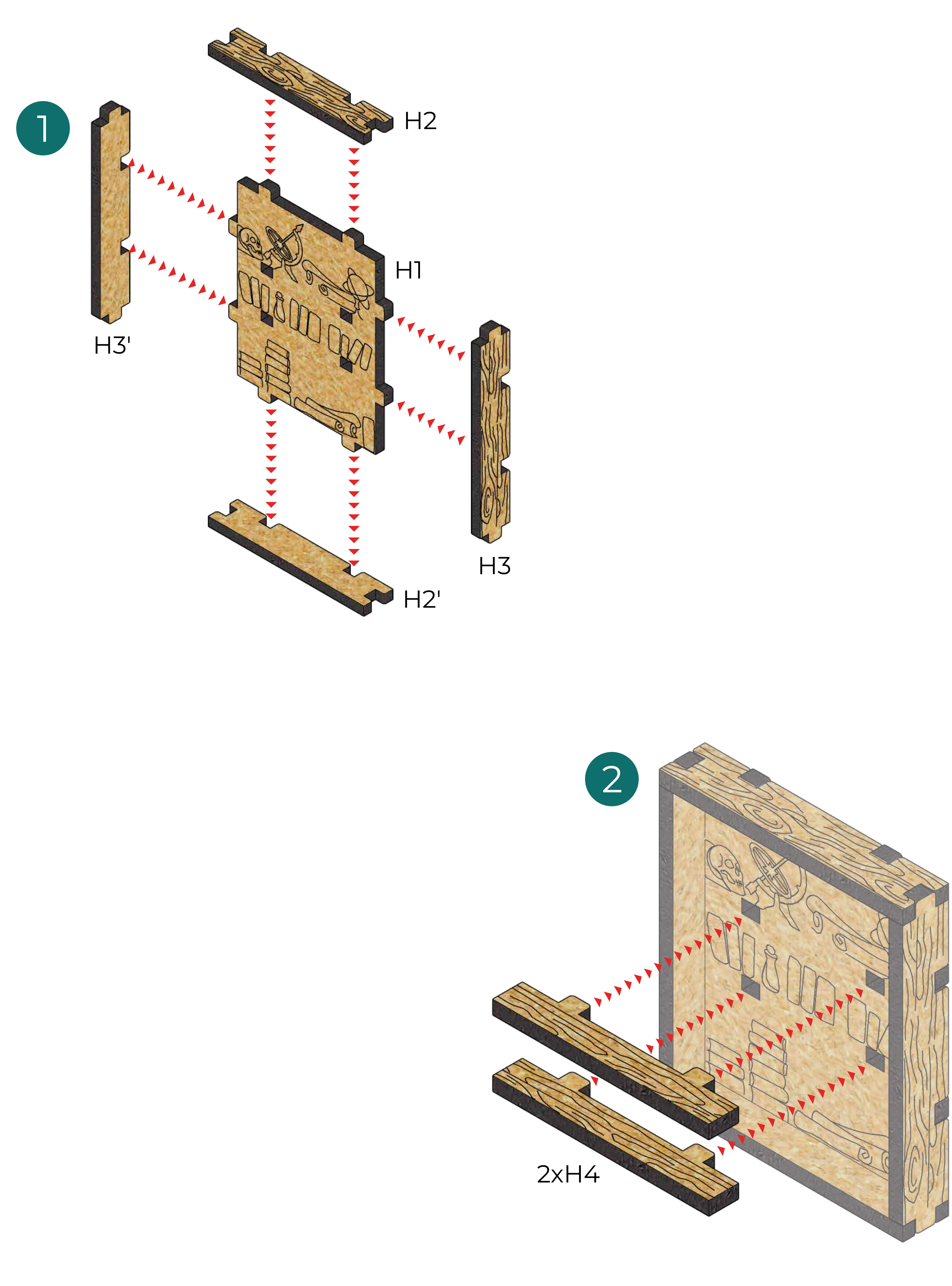

I

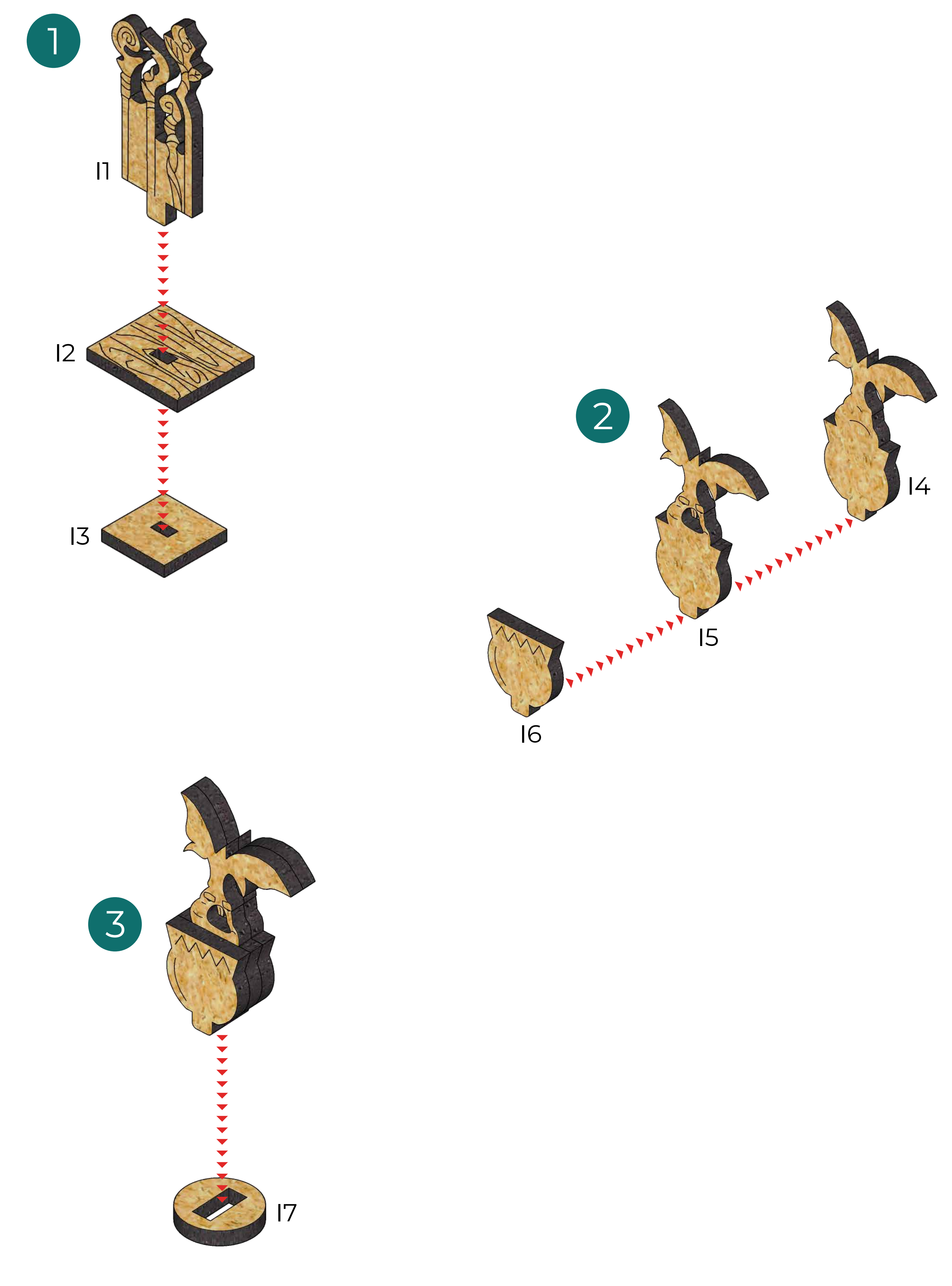

J

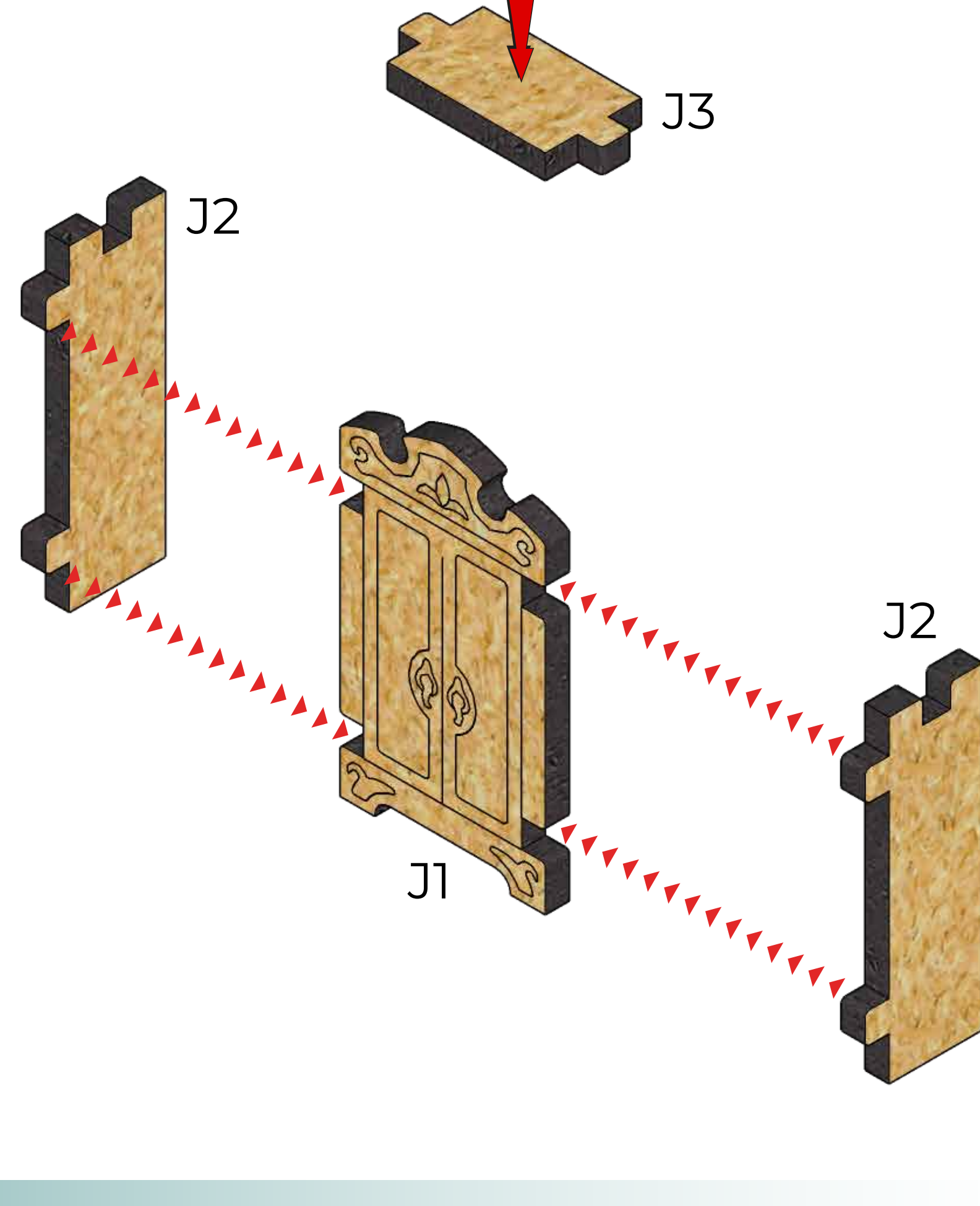

K

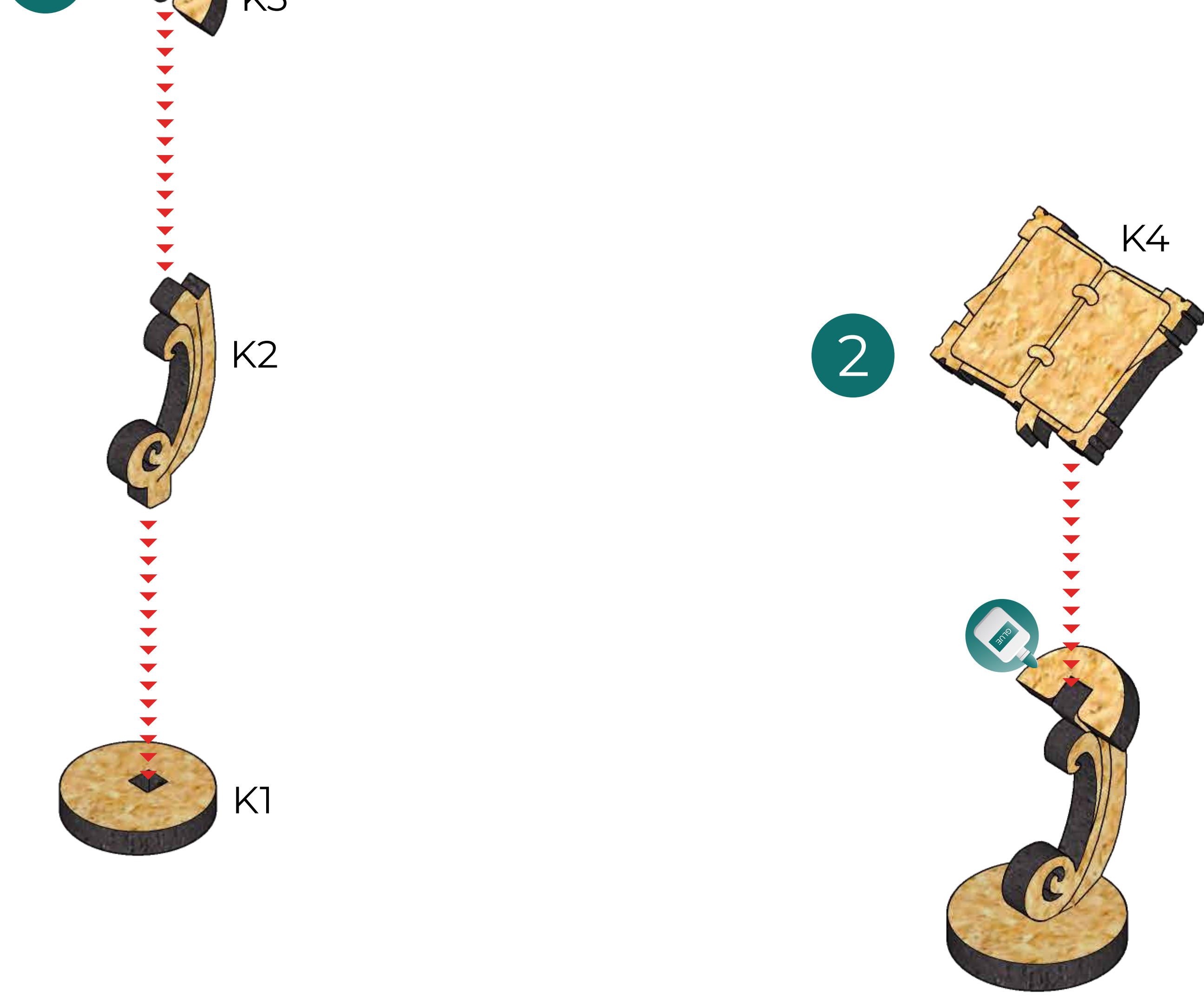

L

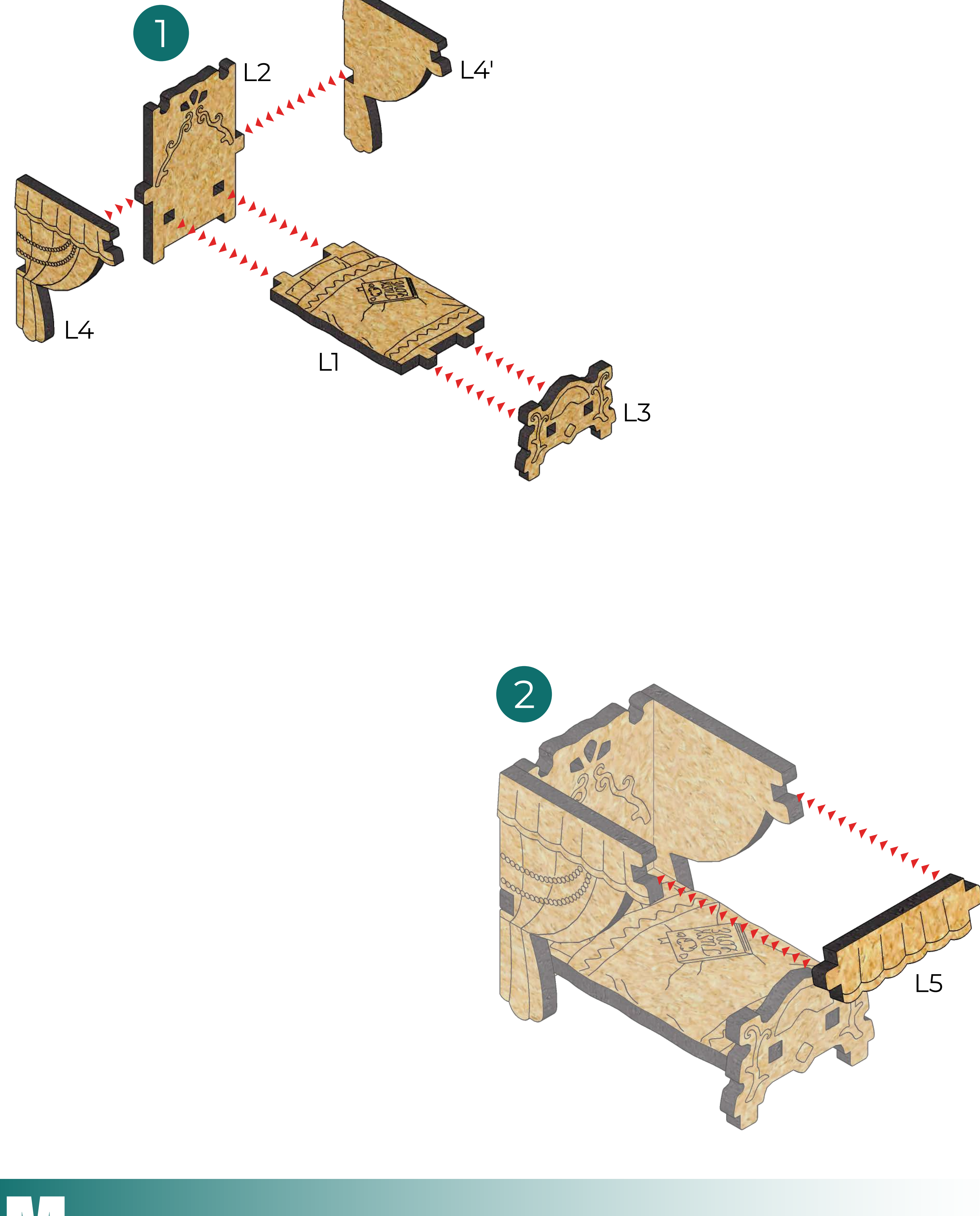

M



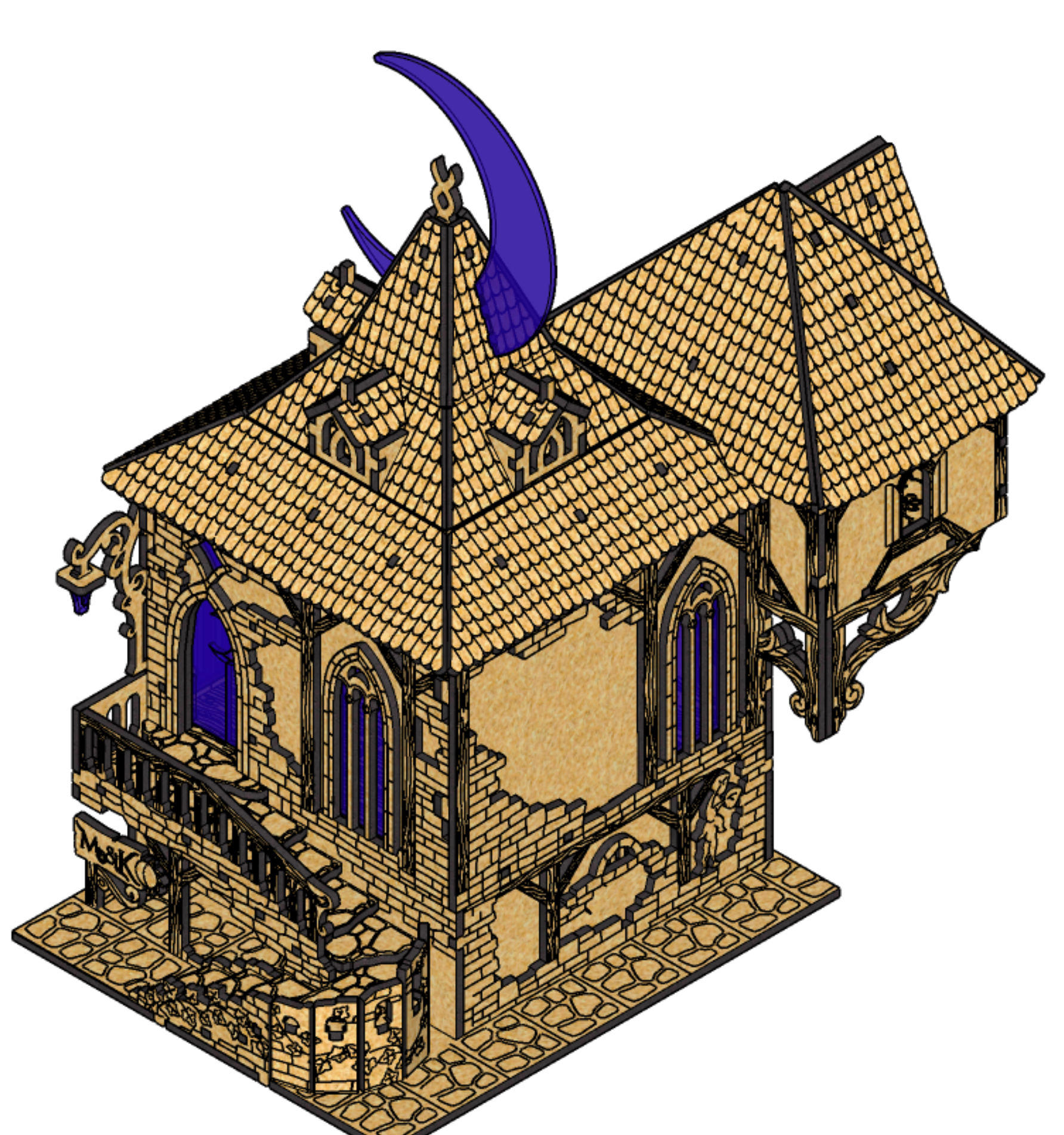
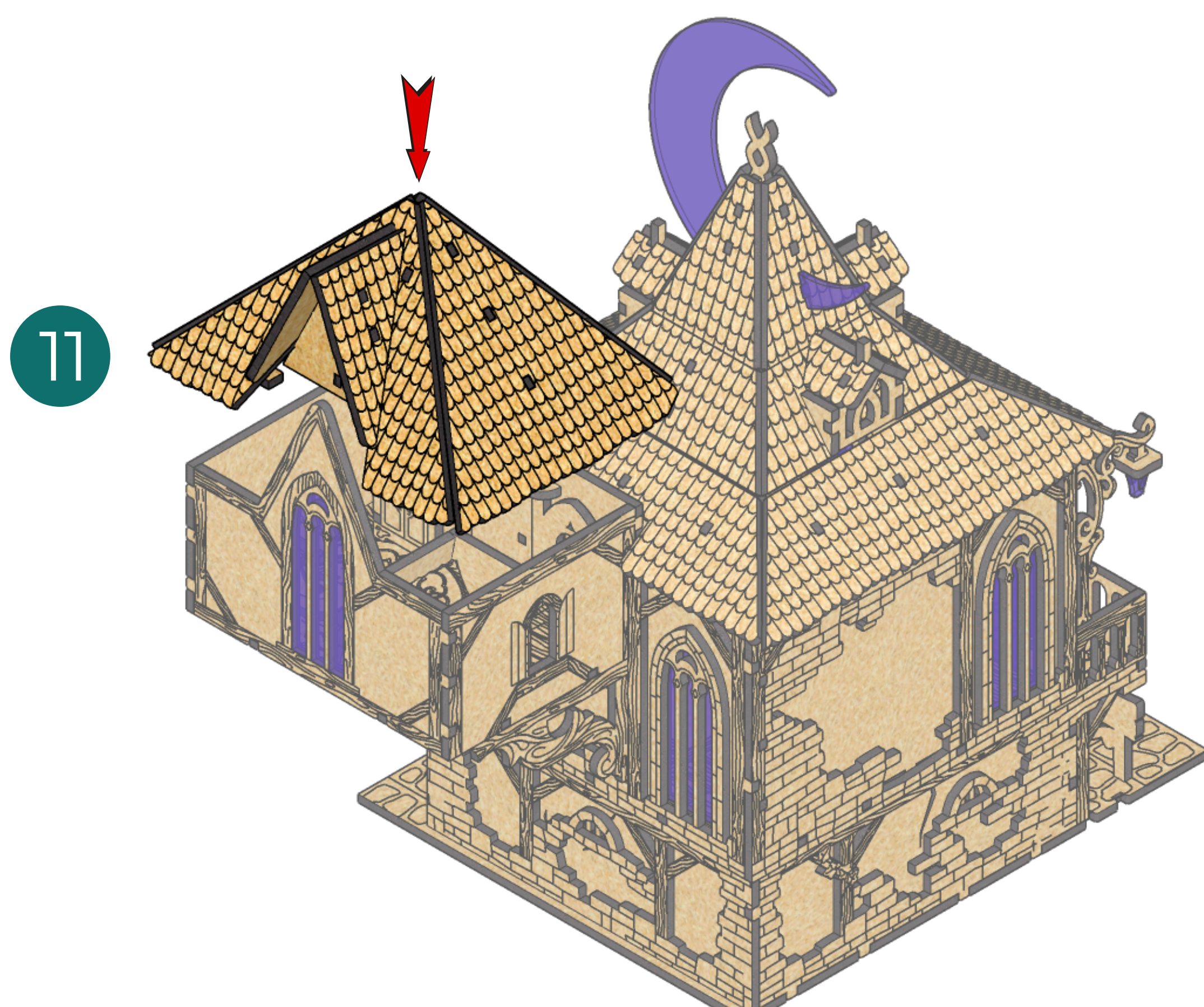
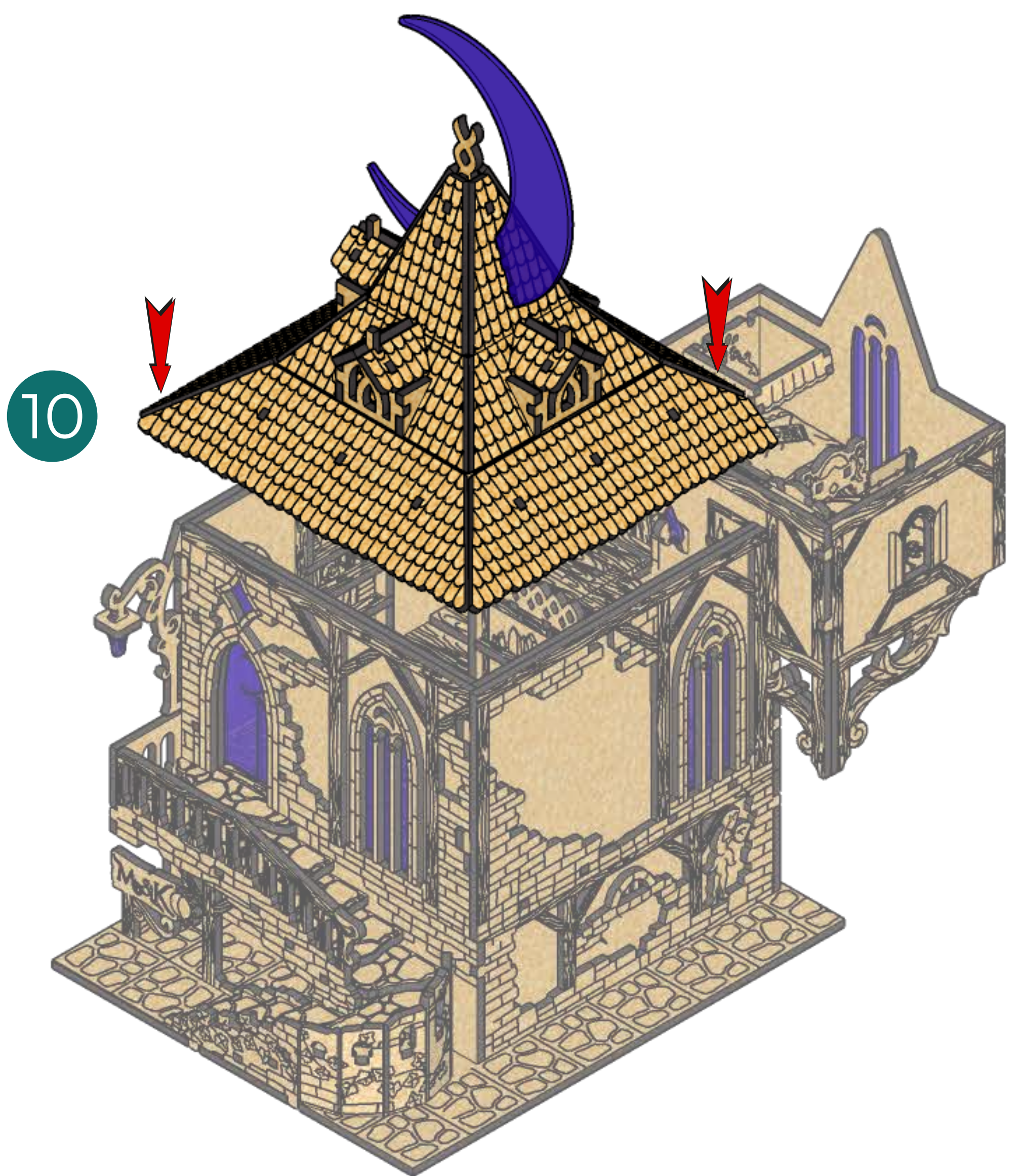
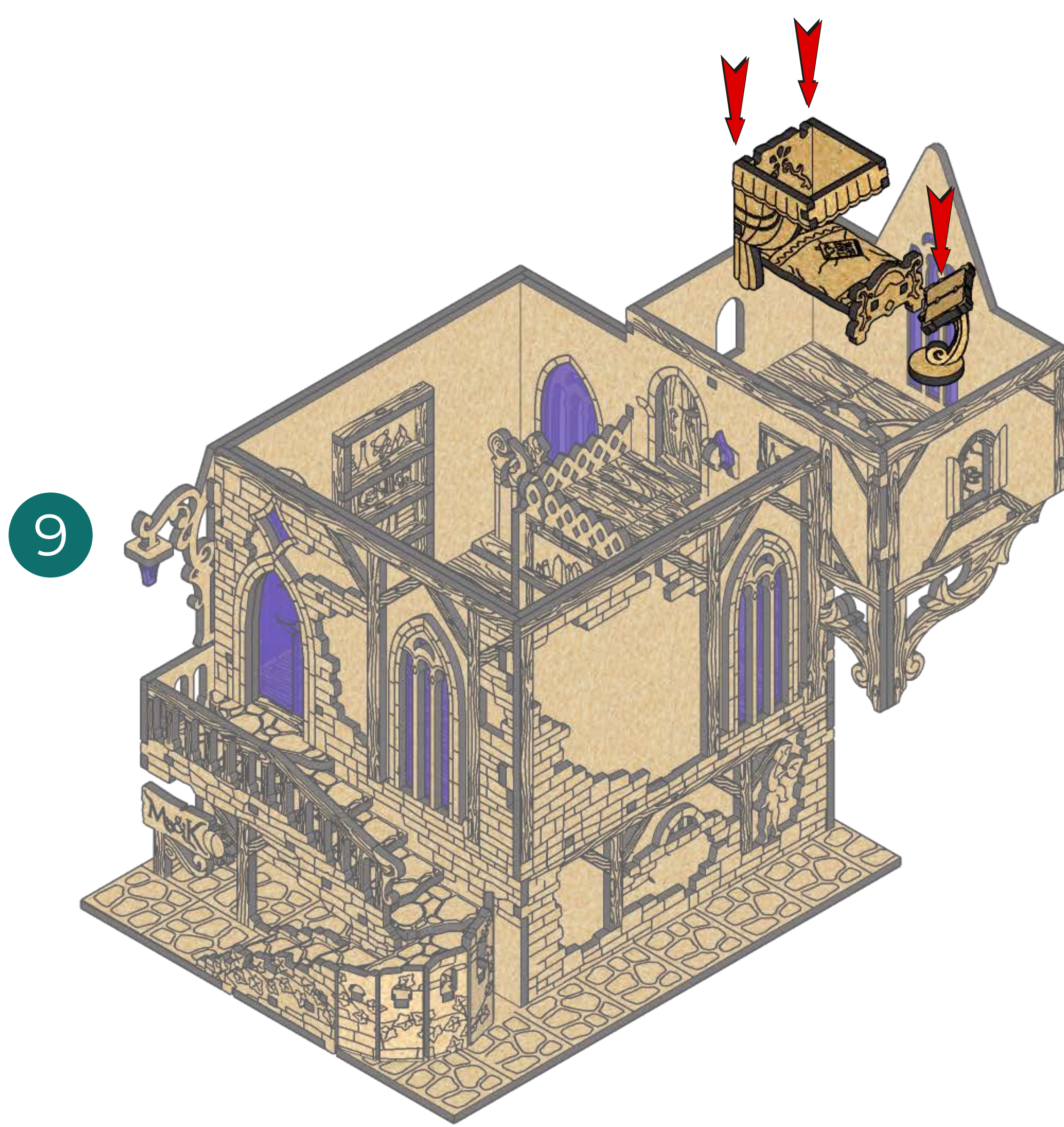
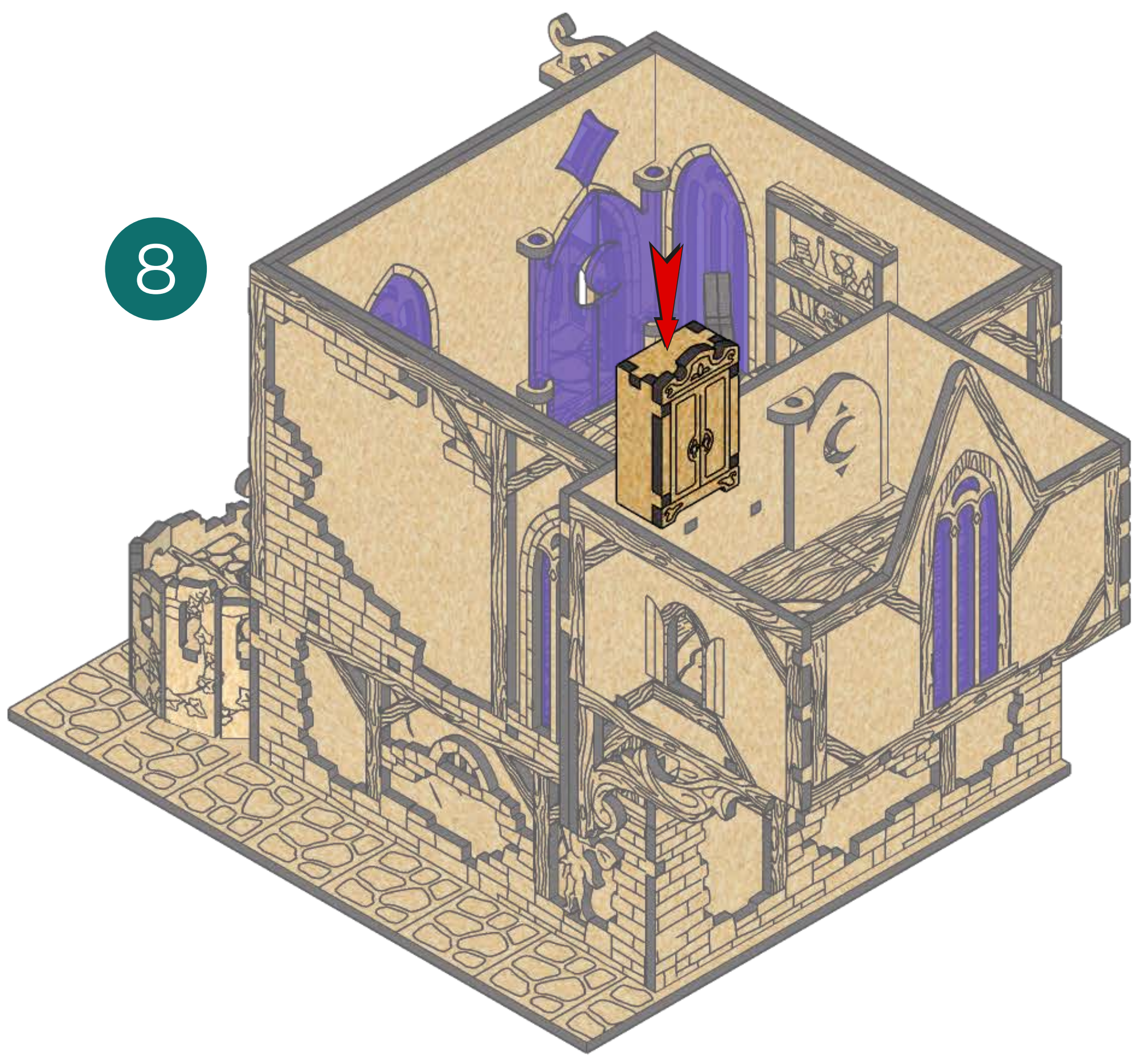
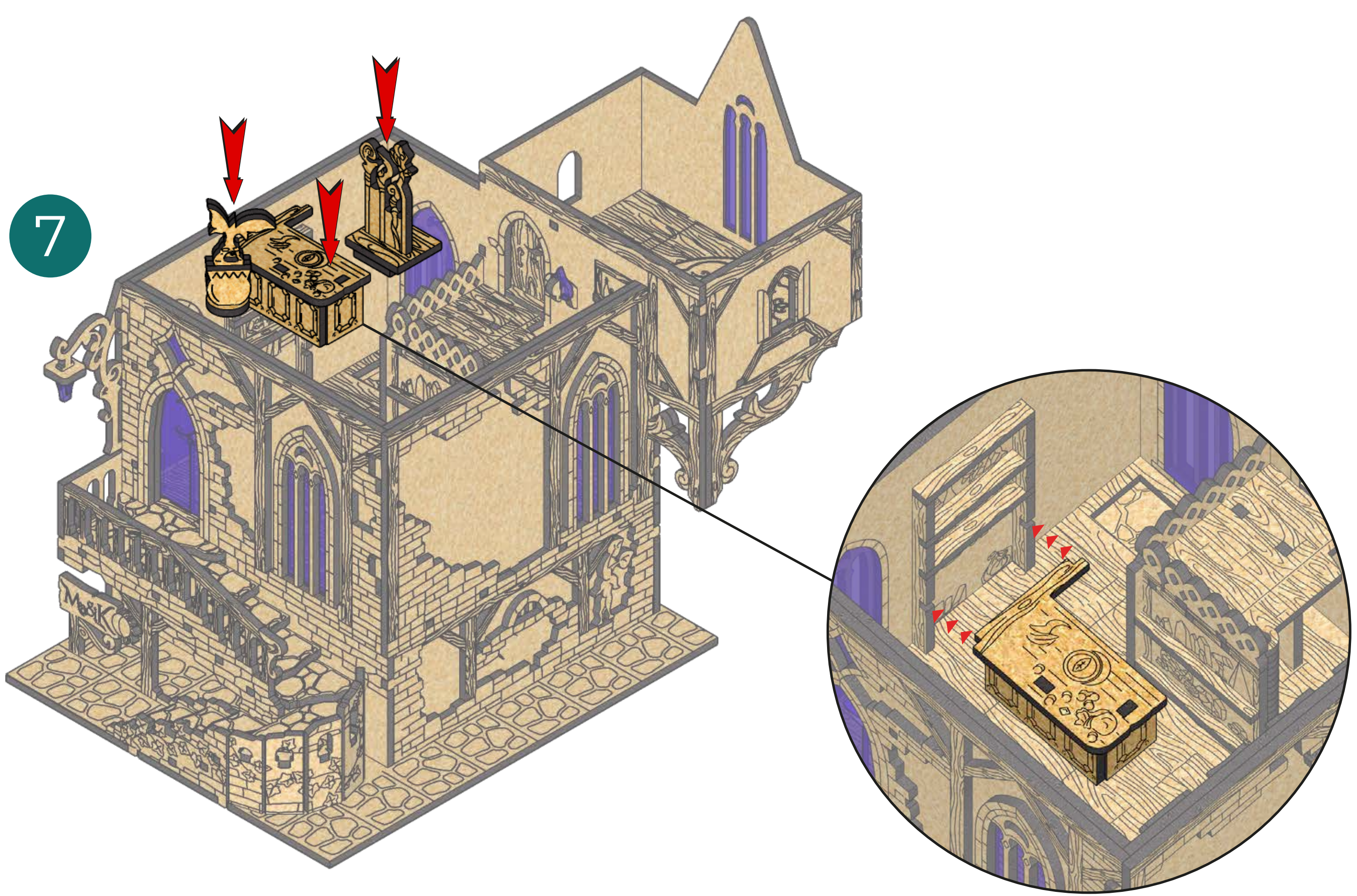

LET'S MAKE GAMING MORE EXCITING TOGETHER!